

# PROFILE

## USER INSTRUCTIONS

*READ CAREFULLY AND KEEP WITH THE CABINET  
(original instructions)*

**EN IT FR DE ES PT**

Modello - Modèle - Model Modell - Modelo - Modelo	<b>PROFILE</b>	 <small>epta refrigeration</small>
Fabbricante - Constructeur - Manufacturer Hersteller - Fabricante - Fabricante	<b>Epta Spa</b> - Via Mecenate, 86 - 20138 Milano (MI) ITALIA Tel. 02/55403211 Telefax 02/55401023	<b>2/3</b>

User Manual

- EN
- IT
- FR
- DE
- ES
- PT

Modello - Modèle - Model Modell - Modelo - Modelo	<b>PROFILE</b>	 epta refrigeration
Fabbricante - Constructeur - Manufacturer Hersteller - Fabricante - Fabricante	<b>Epta Spa</b> - Via Mecenate, 86 - 20138 Milano (MI) ITALIA Tel. 02/55403211 Telefax 02/55401023	<b>3/3</b>

<b>EN</b>	<b>USER INSTRUCTIONS</b> READ CAREFULLY AND KEEP WITH THE CABINET <i>(original instructions)</i>	<b>EN</b>
<b>IT</b>	<b>ISTRUZIONI D'USO PER L'UTENTE</b> LEGGERE ATTENTAMENTE E CONSERVARE CON CURA ASSIEME AL MOBILE <i>(traduzione delle istruzioni originali)</i>	<b>IT</b>
<b>FR</b>	<b>INSTRUCTIONS POUR L'UTILISATEUR</b> LIRE AVEC ATTENTION CE MANUEL ET LE CONSERVER PRÈS DU MEUBLE AVEC SOIN <i>(traduction de la notice originale)</i>	<b>FR</b>
<b>DE</b>	<b>BETRIEBSANLEITUNG FÜR BETREIBE</b> SORGFÄLTIG LESEN UND MIT DEM MÖBEL AUFBEWAHREN <i>(Übersetzung der Originalanweisungen)</i>	<b>DE</b>
<b>ES</b>	<b>INSTRUCCIONES DE USO PARA EL USUARIO</b> LEER ATENTAMENTE Y CONSERVAR CON CUIDADO JUNTO AL MUEBLE <i>(traducción de las instrucciones originales)</i>	<b>ES</b>
<b>PT</b>	<b>INSTRUÇÕES PARA O USO</b> LER COM ATENÇÃO E GUARDAR COM CUIDADO JUNTO AO MÓVEL <i>(tradução das instruções originais)</i>	<b>PT</b>

Modello - Modèle - Model Modell - Modelo - Modelo	<b>PROFILE</b>	 epta refrigeration
Fabbricante - Constructeur - Manufacturer Hersteller - Fabricante - Fabricante	<b>Epta Spa</b> - Via Mecenate, 86 - 20138 Milano (MI) ITALIA Tel. 02/55403211 Telefax 02/55401023	<b>4/32</b>

- EN**
- IT
- FR
- DE
- ES
- PT

## SYMBOLS USED



Prohibition symbol: it prohibits the carrying out of specific operations.



Attention symbol: accident prevention rules for the operator.



Warning symbol: there is the possibility of damaging the cabinet and/or its components.



Note symbol: it provides useful information.

Modello - Modèle - Model Modell - Modelo - Modelo	<b>PROFILE</b>	 eptarefrigeration
Fabbricante - Constructeur - Manufacturer Hersteller - Fabricante - Fabricante	<b>Epta Spa</b> - Via Mecenate, 86 - 20138 Milano (MI) ITALIA Tel. 02/55403211 Telefax 02/55401023	<b>5/32</b>

**CONTENT**

<b>1. Introduction</b>	<b>6</b>	<b>EN</b>
<b>2. Safety warnings</b>	<b>7</b>	<b>IT</b>
2.1 General warnings	7	
2.2 Warnings for cabinet maintenance	9	<b>FR</b>
2.3 Electrical warnings	9	
2.4 Prohibitions	10	<b>DE</b>
<b>3. General description</b>	<b>11</b>	<b>ES</b>
3.1 Sections	13	
<b>4. Transportation of the cabinet</b>	<b>19</b>	<b>PT</b>
<b>5. Ambient conditions</b>	<b>20</b>	
6.1 Reference of models/designation	21	
<b>6. Technical features</b>	<b>21</b>	
<b>7. Use of cabinet</b>	<b>22</b>	
<b>8. Ordinary maintenance</b>	<b>24</b>	
8.1 Cleaning the cabinet	24	
<b>9. Shelves configuration</b>	<b>25</b>	
<b>10. User indications</b>	<b>26</b>	
10.1 Description of the cabinet	26	
10.2 Transport and handling	26	
10.3 Receipt and storage	26	
10.4 Installation and ambient conditions	27	
10.5 Electrical connection	27	
10.6 Technical features	27	
10.7 Loading the product	27	
10.8 Use of cabinet	28	
10.9 Cleaning and ordinary maintenance	28	
10.10 Emergency situations	29	
10.11 Technical assistance	29	
10.12 Dismantling and elimination	30	
<b>11. Supplementary general warnings</b>	<b>31</b>	

Modello - Modèle - Model Modell - Modelo - Modelo	<b>PROFILE</b>	 eptarefrigeration
Fabbricante - Constructeur - Manufacturer Hersteller - Fabricante - Fabricante	<b>Epta Spa</b> - Via Mecenate, 86 - 20138 Milano (MI) ITALIA Tel. 02/55403211 Telefax 02/55401023	<b>6/32</b>

## 1. INTRODUCTION

EN

IT

FR

DE

ES

PT

It is recommended to attentively read the content of this Manual and keep it together with the cabinet.

The manufacturer shall not be held liable for any harm caused to people or damage to property due to the failure to observe the warnings contained in this Manual.

This user manual applies to a product family available in different configurations and sizes; the performance and specifications of each model are supplemented by the information provided on the rating plate, the EC Declaration of Conformity, as well as by the energy label and the related EPREL product information sheet.

The performance of each individual model may vary depending on the specific configuration. The energy label and the product information sheet are also available at <https://eprel.eptarefrigeration.com> by entering the serial number shown on the rating plate.



The Manual contains information considered necessary for the good use and operation of the cabinet.

Inside you will find the following descriptions and information:

- a functional description of the cabinet and each of its parts
- information on the safety of the cabinet and the safety rules to follow
- a correct use of the cabinet
- a correct ordinary and programmed maintenance, including cleaning operations

Information not contained in this Manual:

- Installation instructions

For the correct installation of the cabinet refer to the following documents:

- Technical Manual
- Quick Reference Instructions

This Manual is for the following professional figures:

- **QUALIFIED OPERATOR:** a qualified person, educated to operate, regulate, clean and carry out ordinary maintenance on the cabinet
- **SPECIALISED TECHNICIAN** a technician trained and authorised by the body indicated in the contract (manufacturer/concessionaire/distributor) to carry out: installation, non-routine maintenance, repair, replacement and overhaul of the cabinet

Instructions for use are also available on: [www.eptarefrigeration.com](http://www.eptarefrigeration.com).

**Make reference to the declaration of conformity for the regulations and certifications of the cabinet.**

**Always keep the instruction booklet and in case of sale.**

Modello - Modèle - Model Modell - Modelo - Modelo	<b>PROFILE</b>	 eptarefrigeration
Fabbricante - Constructeur - Manufacturer Hersteller - Fabricante - Fabricante	<b>Epta Spa</b> - Via Mecenate, 86 - 20138 Milano (MI) ITALIA Tel. 02/55403211 Telefax 02/55401023	<b>7/32</b>

## 2. SAFETY WARNINGS

### 2.1 General warnings



The designation of the appliance is provided on page "21".



This device is designed to operate in ambient class 3 or 4; the definition of the ambient class is provided on page "32".



The manufacturer disclaims any liability for damage caused to people or property due to the failure to observe the warnings contained in this manual. Any person who uses this cabinet must read this user manual.



All handling, transport, assembly and disassembly operations, during decommissioning and during disposal, must be carried out exclusively by qualified personnel.



The employer must educate staff on the risks of accidents, on the devices arranged for staff safety, on the risks of noise emission and on the general safety rules provided for by the rules in force.



Technical use of the counter is limited solely to authorised and trained persons; technical activities include, by way of example, switching on the counter, adjustments, cleaning and maintenance.



Use of the counter for non-technical purposes, such as opening the doors to take out products on display, may also be carried out by children aged 8 years or older, or by persons with reduced physical, sensory or mental capabilities or lack of experience and knowledge if they have been given supervision or instruction concerning the use of the appliance in a safe way and understand the hazards involved.

The children have to be supervised not to play with the appliance. Cleaning and user maintenance shall not be made by children without supervision.



Any other use not explicitly indicated in this manual is considered dangerous and the manufacturer cannot be held liable for any damage deriving from improper, wrong and unreasonable use.



The cabinet must be used by staff equipped with the appropriate personal protection equipment.



Instruct anyone who uses the cabinet on the position of the disconnect switch.



It is compulsory to use work gloves.



The removal of protection devices or panels that require the use of tools to be removed is reserved exclusively for qualified personnel.

EN

IT

FR

DE

ES

PT

Modello - Modèle - Model Modell - Modelo - Modelo	<b>PROFILE</b>	 epta refrigeration
Fabbricante - Constructeur - Manufacturer Hersteller - Fabricante - Fabricante	<b>Epta Spa</b> - Via Mecenate, 86 - 20138 Milano (MI) ITALIA Tel. 02/55403211 Telefax 02/55401023	<b>8/32</b>

## User Manual

EN

 Each intervention must be carried out exclusively by qualified personnel and, in every case, before each intervention the power supply of the cabinet must be disconnected.

IT

FR

DE

ES

PT

 Thermostat adjustment is reserved for the technical after-sales service only.

 For assembling dedicated optional accessories, contact your nearest authorised service centre.

 Do not leave the cabinet exposed to weathering agents

 Do not use direct or indirect jets of water on the cabinet.

 Do not touch the cabinet with wet or damp hands and feet; do not use the cabinet with naked feet.

 Pay attention to the hot or moving parts marked with the appropriate symbol.

 Do not damage the refrigeration circuit.

 Avoid fire or sparks inside the appliance.

 In case of fire, do not use water to put out the flames but only dry fire extinguishers

 Do not use electrical appliances inside the compartments of the appliance for the preservation of fresh or frozen food if these are not the type recommended by the manufacturer.

 Do not store explosive or dangerous substances, such as containers under pressure with flammable propellant, in this appliance.

 Do not place liquid containers and do not pour liquids on the counter.

 Keep the ventilation openings in the appliance housing free from obstructions.

 The information regarding the maximum loading of each type of shelf is provided on page "27".

 Do not leave weights on top of the cabinet roof resting unpacked products directly on the shelves should be avoided, use suitable food containers.

Modello - Modèle - Model Modell - Modelo - Modelo	<b>PROFILE</b>	 eptarefrigeration
Fabbricante - Constructeur - Manufacturer Hersteller - Fabricante - Fabricante	<b>Epta Spa</b> - Via Mecenate, 86 - 20138 Milano (MI) ITALIA Tel. 02/55403211 Telefax 02/55401023	<b>9/32</b>

## 2.2 Warnings for cabinet maintenance

 Maintenance work must only be carried out by authorised personnel.

 Access to the electrical parts and/or parts that require the use of tools is reserved for specialist technicians.

 Prior to any maintenance and cleaning operation reserved for the user, de-energise the cabinet using the wall-mounted disconnect switch.

 Pay attention to the hot or moving parts marked with the appropriate symbol.

 It is compulsory to use work gloves.

 It is important to respect the type and frequency of inspections and maintenance required for safe operation including the preventive maintenance measures, as described in the paragraph "Cleaning and ordinary maintenance" on page "28".

## 2.3 Electrical warnings

 Ensure that the power voltage corresponds to the rating plate of the cabinet.

 The electrical installation must be carried out in a competent manner by specialised technicians.

 The removal of the cover of the electrical panel is reserved for specialist technicians.

 In compliance with the installation rules, the power supply must include an omnipolar disconnection device, which ensures complete disconnection from the network in overvoltage category III conditions.

 The cabinet must be installed following the instructions of the manufacturer, by professionally qualified staff and in compliance with the rules on electrical systems in force in individual Countries.

 A wrong cabinet installation can cause damage to people, animals or property, for which the manufacturer cannot be held liable.

 If the power cord is damaged, it must be replaced by authorized service personnel to avoid any hazard. Do not attempt to repair the cable.

 Do not power the cable if it is damaged. If in doubt, contact the after-sales service or your dealer.

EN

IT

FR

DE

ES

PT

Modello - Modèle - Model Modell - Modelo - Modelo	<b>PROFILE</b>	 epta refrigeration
Fabbricante - Constructeur - Manufacturer Hersteller - Fabricante - Fabricante	<b>Epta Spa</b> - Via Mecenate, 86 - 20138 Milano (MI) ITALIA Tel. 02/55403211 Telefax 02/55401023	<b>10/32</b>

## 2.4 Prohibitions

 It is forbidden to use devices in addition to those provided in the cabinet by the manufacturer to accelerate the defrosting process.

 It is forbidden for unskilled staff to remove the cover of the electrical panel or open panels that require the use of tools.

 It is forbidden to use the cabinet for the preservation and/or display of explosive, flammable or corrosive substances, such as spray cans containing a flammable propellant.

 It is forbidden to use the cabinet for the preservation and/or display of pharmaceutical products.

 It is forbidden to place the cabinet in areas with the presence of explosive gaseous substances.

 It is forbidden to remove the identification plate from the cabinet.

 It is forbidden to get on the counter or on the counter bumper.

 It is forbidden to replace components and/or make changes to the cabinet outside the manufacturer's specifications, replace original parts with others that are not approved by the manufacturer, under penalty of forfeiture of the warranty.

Modello - Modèle - Model Modell - Modelo - Modelo	<b>PROFILE</b>	
Fabbricante - Constructeur - Manufacturer Hersteller - Fabricante - Fabricante	<b>Epta Spa</b> - Via Mecenate, 86 - 20138 Milano (MI) ITALIA Tel. 02/55403211 Telefax 02/55401023	<b>11/32</b>

### 3. GENERAL DESCRIPTION

Open



1. Rating plate
2. Upper lighting
3. Night blinds
4. Shelves
5. Lateral glasses
6. Light switch
7. Telethermostat

Closed (Glass doors)



1. Rating plate
2. Upper lighting
3. Glass doors
4. Shelves
5. Lateral glasses
6. Light switch
7. Telethermostat

EN

IT

FR

DE

ES

PT

Modello - Modèle - Model Modell - Modelo - Modelo	<b>PROFILE</b>	 epta refrigeration
Fabbricante - Constructeur - Manufacturer Hersteller - Fabricante - Fabricante	<b>Epta Spa</b> - Via Mecenate, 86 - 20138 Milano (MI) ITALIA Tel. 02/55403211 Telefax 02/55401023	<b>12/32</b>

## User Manual

- EN
- IT
- FR
- DE
- ES
- PT

### Closed (Sliding glass doors)



Fig. 4

1. Rating plate
2. Upper lighting
3. Glass sliding doors
4. Shelves
5. Lateral glasses
6. Light switch
7. Telethermostat

Modello - Modèle - Model Modell - Modelo - Modelo	<h1>PROFILE</h1>	
Fabbricante - Constructeur - Manufacturer Hersteller - Fabricante - Fabricante	<b>Epta Spa</b> - Via Mecenate, 86 - 20138 Milano (MI) ITALIA Tel. 02/55403211 Telefax 02/55401023	<b>13/32</b>

### 3.1 Sections

#### H20Open

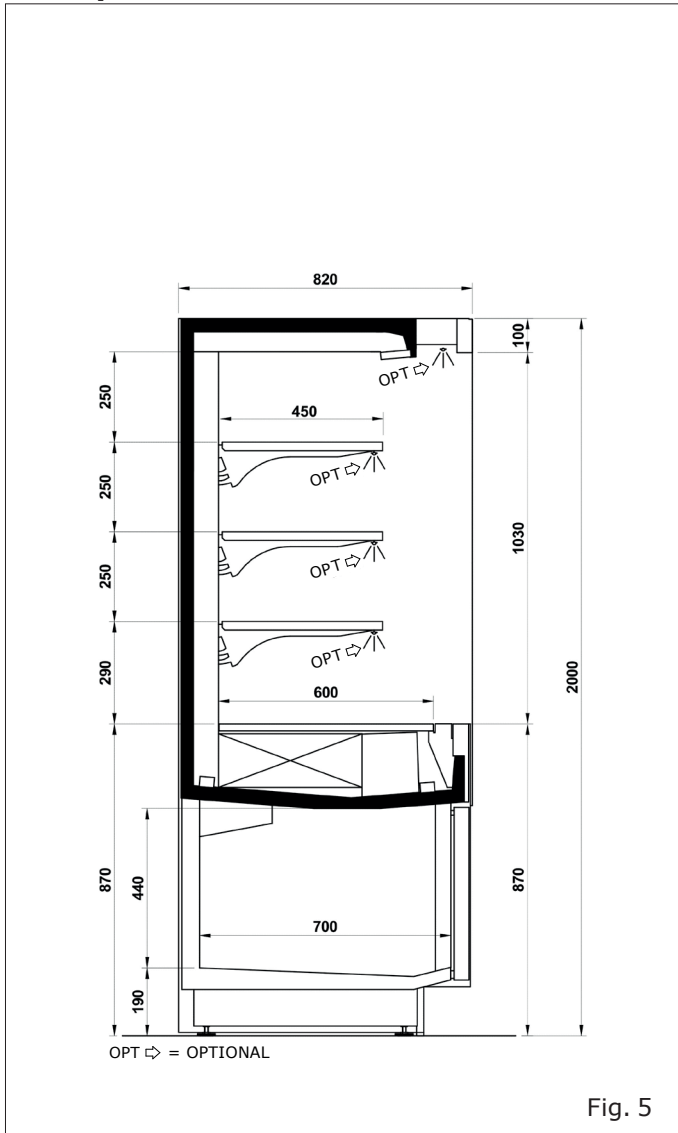

#### H20Open with hooks

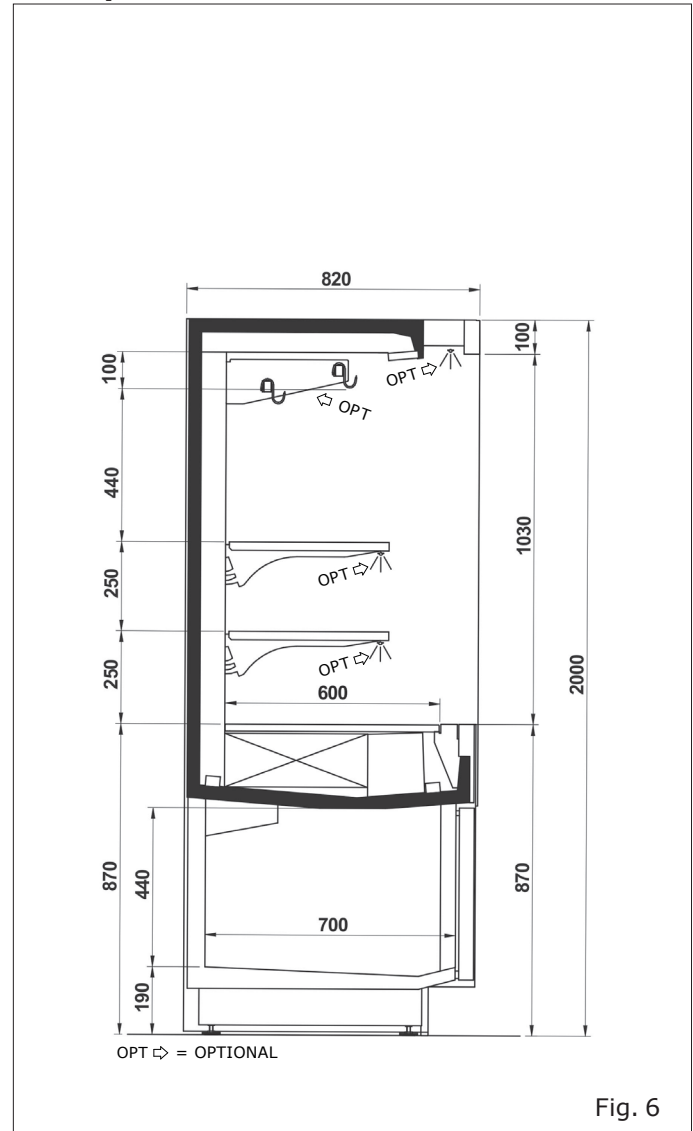

- EN
- IT
- FR
- DE
- ES
- PT

Modello - Modèle - Model Modell - Modelo - Modelo	<b>PROFILE</b>	 epta refrigeration
Fabbricante - Constructeur - Manufacturer Hersteller - Fabricante - Fabricante	<b>Epta Spa</b> - Via Mecenate, 86 - 20138 Milano (MI) ITALIA Tel. 02/55403211 Telefax 02/55401023	<b>14/32</b>

- EN
- IT
- FR
- DE
- ES
- PT

### H20Closed (Glass doors)

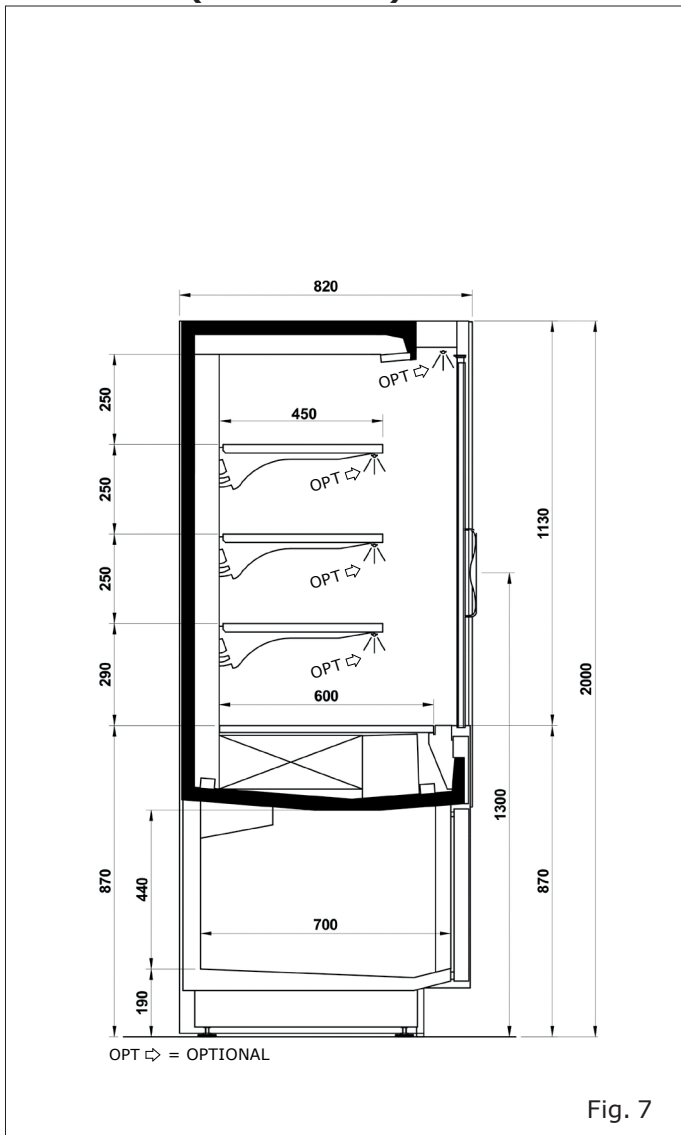

### H20Closed with hooks (Glass doors)

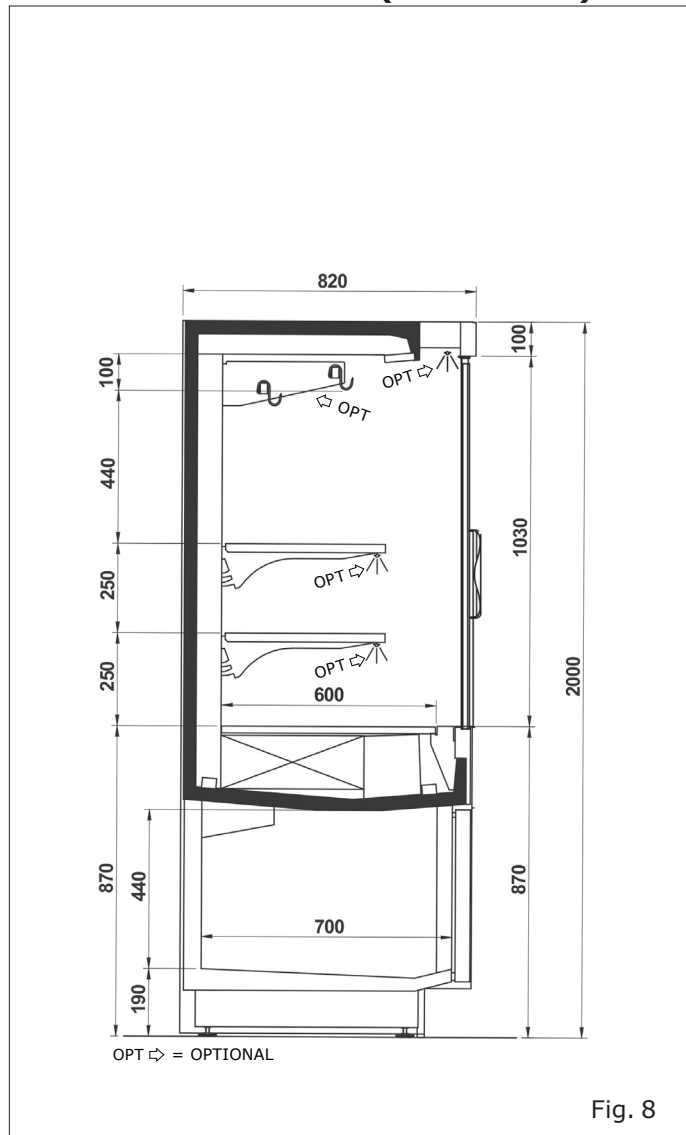

Modello - Modèle - Model Modell - Modelo - Modelo	<h1>PROFILE</h1>	
Fabbricante - Constructeur - Manufacturer Hersteller - Fabricante - Fabricante	<b>Epta Spa</b> - Via Mecenate, 86 - 20138 Milano (MI) ITALIA Tel. 02/55403211 Telefax 02/55401023	<b>15/32</b>

### H20Closed (Sliding glass doors)

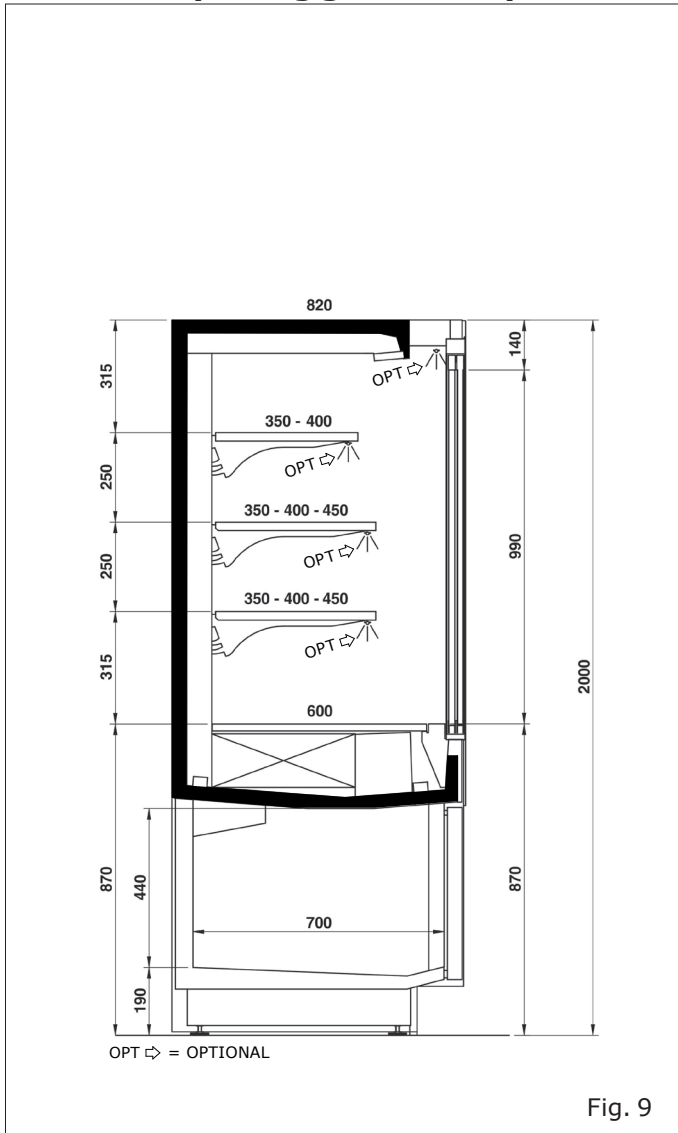

### H22Open

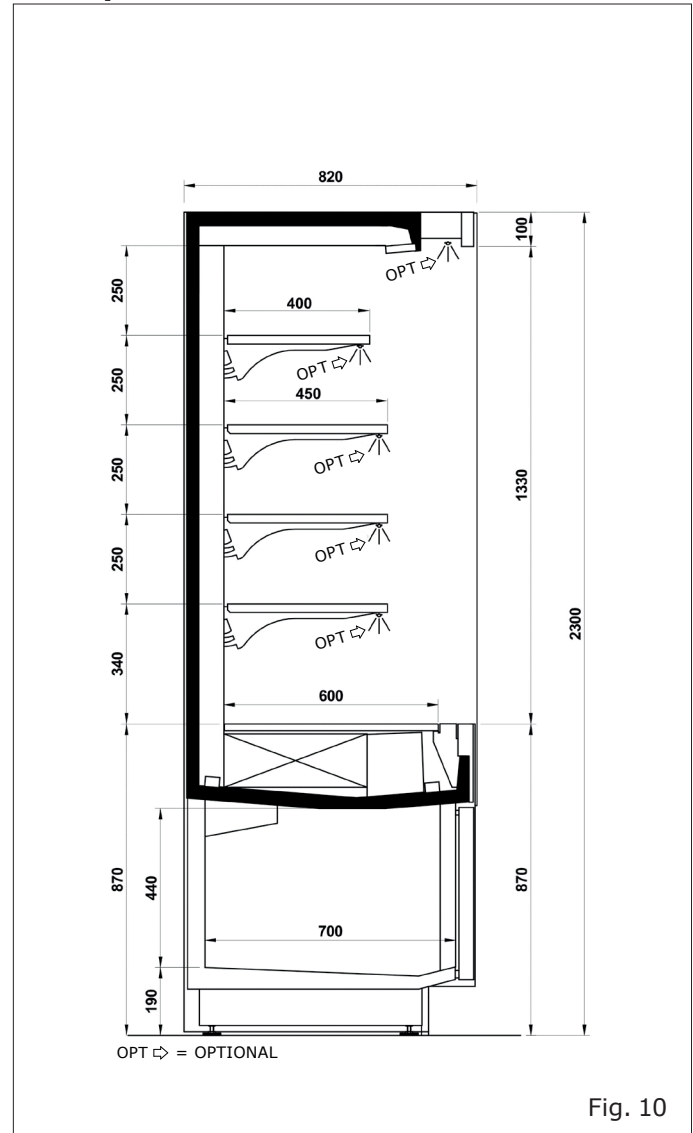

- EN
- IT
- FR
- DE
- ES
- PT

Modello - Modèle - Model Modell - Modelo - Modelo	<b>PROFILE</b>	 epta refrigeration
Fabbricante - Constructeur - Manufacturer Hersteller - Fabricante - Fabricante	<b>Epta Spa</b> - Via Mecenate, 86 - 20138 Milano (MI) ITALIA Tel. 02/55403211 Telefax 02/55401023	<b>16/32</b>

User Manual

- EN
- IT
- FR
- DE
- ES
- PT

**H22Open with hooks**

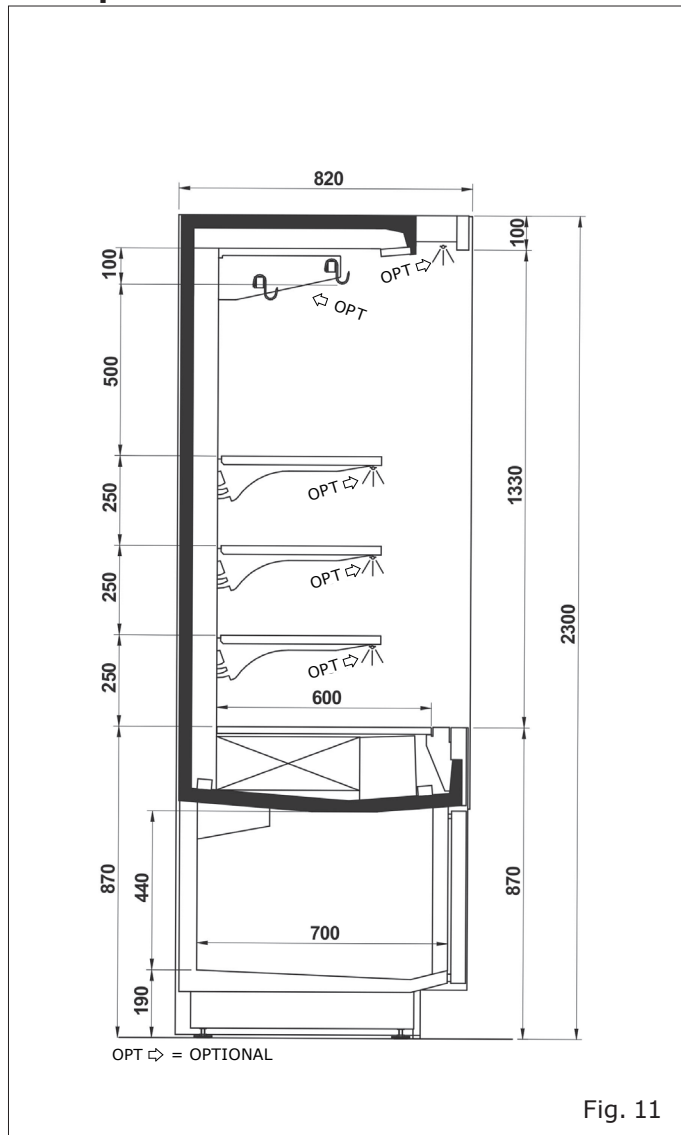

**H22Closed (Glass doors)**

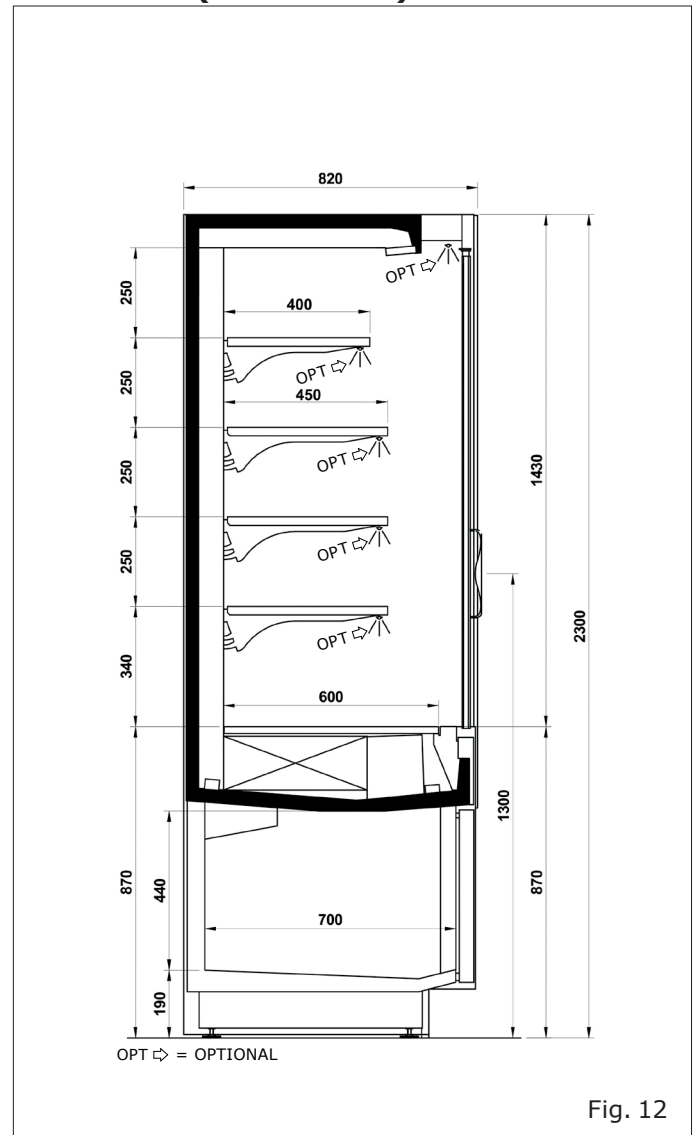

Modello - Modèle - Model Modell - Modelo - Modelo	<b>PROFILE</b>	
Fabbricante - Constructeur - Manufacturer Hersteller - Fabricante - Fabricante	<b>Epta Spa</b> - Via Mecenate, 86 - 20138 Milano (MI) ITALIA Tel. 02/55403211 Telefax 02/55401023	<b>17/32</b>

### H22Closed with hooks (Glass doors)

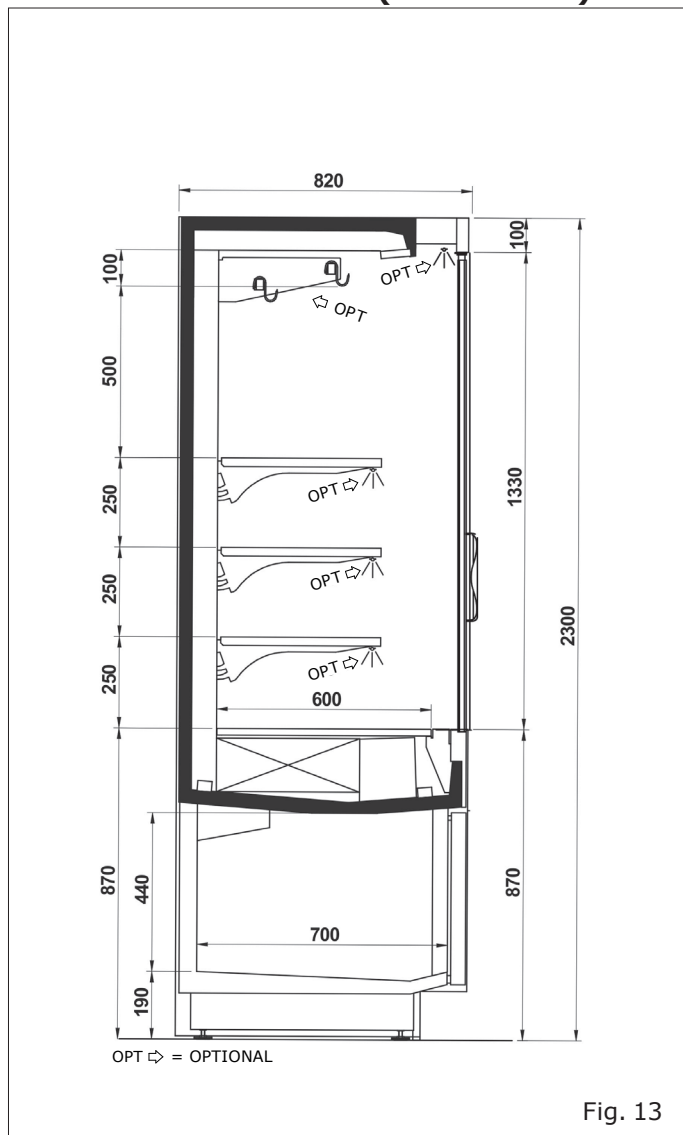

### H22Closed (Sliding glass doors)

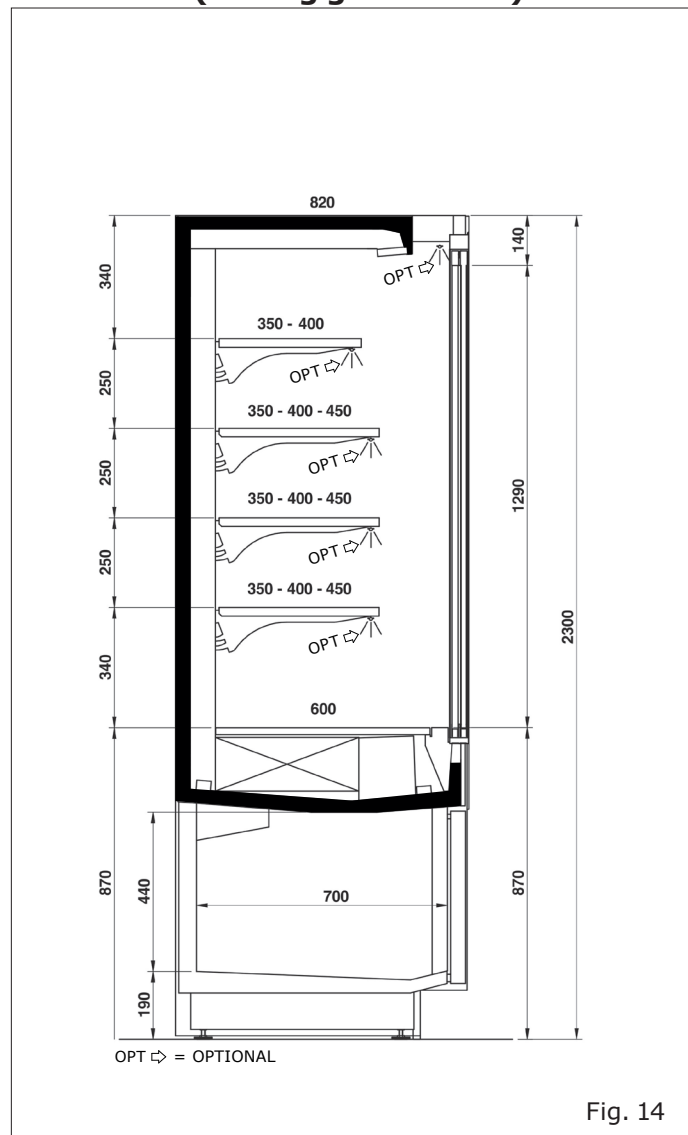

- EN
- IT
- FR
- DE
- ES
- PT

Modello - Modèle - Model Modell - Modelo - Modelo	<b>PROFILE</b>	 epta refrigeration
Fabbricante - Constructeur - Manufacturer Hersteller - Fabricante - Fabricante	<b>Epta Spa</b> - Via Mecenate, 86 - 20138 Milano (MI) ITALIA Tel. 02/55403211 Telefax 02/55401023	<b>18/32</b>

User Manual

- EN
- IT
- FR
- DE
- ES
- PT

**H26Open**

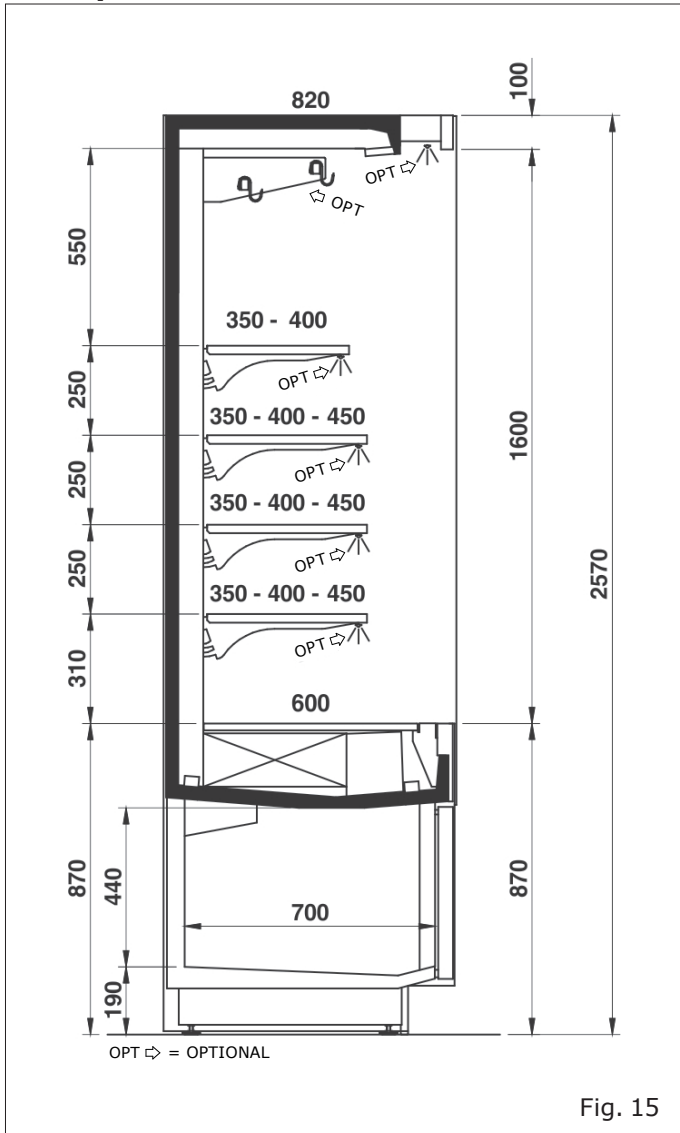

Modello - Modèle - Model Modell - Modelo - Modelo	<b>PROFILE</b>	 eptarefrigeration
Fabbricante - Constructeur - Manufacturer Hersteller - Fabricante - Fabricante	<b>Epta Spa</b> - Via Mecenate, 86 - 20138 Milano (MI) ITALIA Tel. 02/55403211 Telefax 02/55401023	<b>19/32</b>

## 4. TRANSPORTATION OF THE CABINET



### 1. Lifting points

### Chart I

Height	Length	Weight (kg)	Weight with packaging (kg)
2000	1250	85	95
	1875	215	240
	2500	365	400
2300	1250	100	120
	1875	250	280
	2500	400	440
2500	1250	115	135
	1875	285	315
	2500	435	475

Modello - Modèle - Model Modell - Modelo - Modelo	<b>PROFILE</b>	
Fabbricante - Constructeur - Manufacturer Hersteller - Fabricante - Fabricante	<b>Epta Spa</b> - Via Mecenate, 86 - 20138 Milano (MI) ITALIA Tel. 02/55403211 Telefax 02/55401023	<b>20/32</b>

- EN
- IT
- FR
- DE
- ES
- PT

## 5. AMBIENT CONDITIONS



Fig. 18

### Chart II

Characteristics	
Type of premises	Closed
Temperature	25°C
Relative humidity	60 %
Lighting	600 lx



Fig. 19

Modello - Modèle - Model Modell - Modelo - Modelo	<b>PROFILE</b>	 eptarefrigeration
Fabbricante - Constructeur - Manufacturer Hersteller - Fabricante - Fabricante	<b>Epta Spa</b> - Via Mecenate, 86 - 20138 Milano (MI) ITALIA Tel. 02/55403211 Telefax 02/55401023	<b>21/32</b>

## 6. TECHNICAL FEATURES



























			
			
			
			
			
			
			
			

Fig. 20

- |   |  |
|---|--|
| <ol style="list-style-type: none"> <li>1. Origin of the product</li> <li>2. Product in "Country of origin"</li> <li>3. Rated voltage</li> <li>4. Rated power</li> <li>5. Rated frequency</li> <li>6. Rated current</li> <li>7. Defrosting power</li> <li>8. Defrosting current</li> <li>9. Heating system</li> <li>10. Lighting system</li> <li>11. Operator manual</li> <li>12. Barcode</li> </ol> | <ol style="list-style-type: none"> <li>13. Serial number</li> <li>14. Date of production</li> <li>15. Hat Code</li> <li>16. Model/designation</li> <li>17. Type of refrigerant 1</li> <li>18. Refrigerant mass 1</li> <li>19. Type of refrigerant 2</li> <li>20. Refrigerant mass 2</li> <li>21. Climate class</li> <li>22. Gas isolation</li> <li>23. Protection index</li> <li>24. Certification brands</li> </ol> |
|---|--|

### 6.1 Reference of models/designation

The table explains how to read the model code, indicating the relevant commercial information for each part of the reference (see label field number: "16").

#### PROFILE xxx (Refrigerated display cabinet)

Reference/designation	Description	Commercial information
Profile	Name	Profile
xxx	Length	125(1250), 188(1875), 250(2500)

example:  
|v|Profile125 = Profile 1250

Modello - Modèle - Model Modell - Modelo - Modelo	<b>PROFILE</b>	
Fabbricante - Constructeur - Manufacturer Hersteller - Fabricante - Fabricante	<b>Epta Spa</b> - Via Mecenate, 86 - 20138 Milano (MI) ITALIA Tel. 02/55403211 Telefax 02/55401023	<b>22/32</b>

- EN
- IT
- FR
- DE
- ES
- PT

## 7. USE OF CABINET



 Do not cover

Only for open model

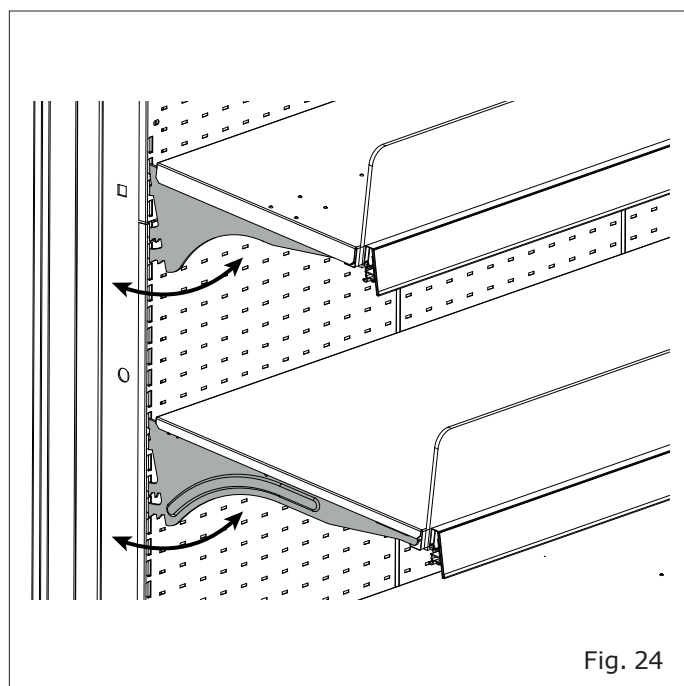

Inclination of shelves: 0° - 7° - 14° - 21°

Modello - Modèle - Model Modell - Modelo - Modelo	<h1>PROFILE</h1>	
Fabbricante - Constructeur - Manufacturer Hersteller - Fabricante - Fabricante	<b>Epta Spa</b> - Via Mecenate, 86 - 20138 Milano (MI) ITALIA Tel. 02/55403211 Telefax 02/55401023	<b>23/32</b>



- EN
- IT
- FR
- DE
- ES
- PT

Modello - Modèle - Model Modell - Modelo - Modelo	<b>PROFILE</b>	
Fabbricante - Constructeur - Manufacturer Hersteller - Fabricante - Fabricante	<b>Epta Spa</b> - Via Mecenate, 86 - 20138 Milano (MI) ITALIA Tel. 02/55403211 Telefax 02/55401023	<b>24/32</b>

EN

## 8. ORDINARY MAINTENANCE

IT

### 8.1 Cleaning the cabinet

FR

DE

ES

PT

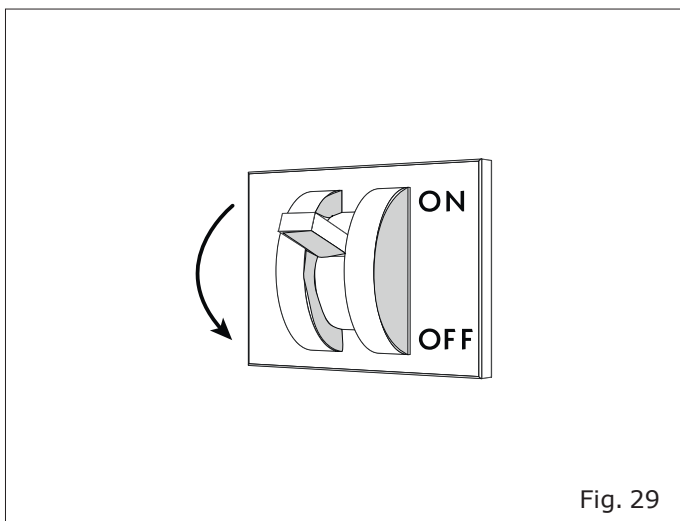

Modello - Modèle - Model Modell - Modelo - Modelo	<b>PROFILE</b>	 epta refrigeration
Fabbricante - Constructeur - Manufacturer Hersteller - Fabricante - Fabricante	<b>Epta Spa</b> - Via Mecenate, 86 - 20138 Milano (MI) ITALIA Tel. 02/55403211 Telefax 02/55401023	<b>25/32</b>

## 9. SHELVES CONFIGURATION

**Chart III**

Single depth shelf configuration			
Level	With hooks	Without hooks	H20
1	x	x	350-400-450 350-400-450
2	x	x	350-400-450 350-400-451
3	x	-	350-400-450 350-400-452

Single depth shelf configuration			
Level	With hooks	Without hooks	H23
1	x	x	350-400-450 350-400-450
2	x	x	350-400-450 350-400-451
3	x	x	350-400-450 350-400-452
4	x	-	350-400-450 350-400-453

Modello - Modèle - Model Modell - Modelo - Modelo	<b>PROFILE</b>	
Fabbricante - Constructeur - Manufacturer Hersteller - Fabricante - Fabricante	<b>Epta Spa</b> - Via Mecenate, 86 - 20138 Milano (MI) ITALIA Tel. 02/55403211 Telefax 02/55401023	<b>26/32</b>

## 10. USER INDICATIONS

### 10.1 Description of the cabinet

This display case was designed and manufactured exclusively for the display of fresh packed food, drinks and dairies.

TEMPERATURE CLASS (according to EN ISO 23953-2):

- Open H20/H23: 3M1/3M2, H26: 3M2
- Closed H20/H23/H26: 3M1

The general characteristics and the dimensions are illustrated in the figures and in the sections contained in "General description" (from pg. "11" to pg. "18").

The recommended temperature settings for each compartment, for optimal food storage, are indicated in the product information sheet available in EPREL or by accessing the website <https://eprel.eptarefrigeration.com> and following the instructions provided for database access.

During transport and handling, receipt and storage, installation, loading, use, cleaning and maintenance, dismantling, pay attention to the risk of overturning the cabinet ("Fig. 31").

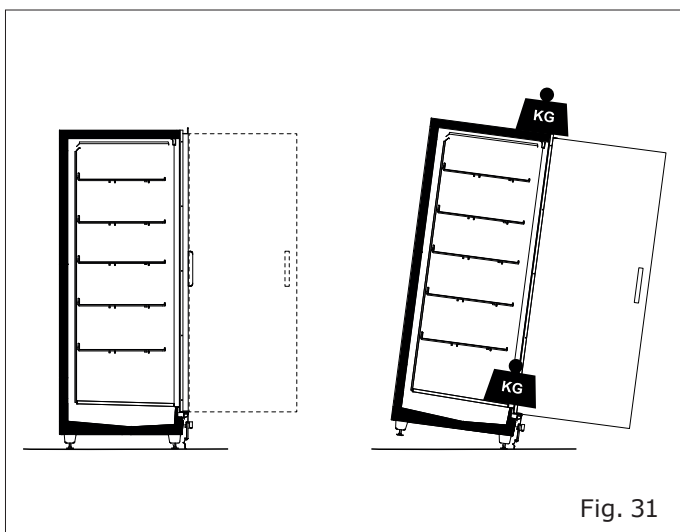

Fig. 31

### 10.2 Transport and handling

The cabinet is contained in a specific packaging equipped with a platform for handling with forklift trucks.

To transport and handle the cabinet use:

- Exclusively a dedicated or equivalent platform
- A manual or electric forklift suited to lifting the cabinet, with characteristics that comply with current Standards

The weights of the cabinet (empty and with packaging) and the dimensions of the packaging are shown in "Transportation of the cabinet" (chart "Chart I" and figures at pg. "19").

The handling operations must be carried out by qualified staff able to assess weights, lifting points and most suitable means in terms of safety and capacity.

### 10.3 Receipt and storage

Check conditions of the packaging before accepting the cabinet from the carrier.

If there is obvious damage in the packaging:

- Remove the packaging of the cabinet in the presence of the carrier.
- Sign the delivery document with reservation.

The manufacturer shall not be held responsible for any damage caused due to transport or incorrect storage of the cabinet.

The cabinet must be stored in a place sheltered from sun and weather, with a temperature of between -25°C and +55°C and a relative humidity of the air between 30% and 95%.

Modello - Modèle - Model Modell - Modelo - Modelo	<b>PROFILE</b>	
Fabbricante - Constructeur - Manufacturer Hersteller - Fabricante - Fabricante	<b>Epta Spa</b> - Via Mecenate, 86 - 20138 Milano (MI) ITALIA Tel. 02/55403211 Telefax 02/55401023	<b>27/32</b>

## 10.4 Installation and ambient conditions

The cabinet is not designed to be installed outdoors.

For a correct operation of the cabinet, ensure that it is positioned:

- On a levelled floor ("Fig. 18").
- Far from heat sources, from the direct radiation of the sun, from doors, windows, fans and air vents ("Fig. 19").

Provide the space necessary for the use of the cabinet by the client.

The ambient conditions in which the cabinet should be placed are set out in: "Ambient conditions" (chart "Chart II", Pg."20").

## 10.5 Electrical connection

An omnipolar disconnecter switch must be installed upstream of the cabinet. This must have adequate breaking power.

The isolator switch must be positioned upstream of the unit and either be visible to the operator during cleaning and maintenance, or fitted with a locking device to secure it in the isolated (off) position.

Before connecting the cabinet, ensure that the supply voltage corresponds to the rating plate data of the cabinet. To guarantee smooth operation, the maximum voltage variation must be between +/- 6% of the nominal value.

## 10.6 Technical features

The identification plate shows the characteristic technical data of the cabinet. Its position and the type of data are shown in: "Technical features" ("Fig. 20").

Wiring diagrams, control instrument calibration lists, installation instructions and copy of the Declaration of Conformity are available on the website <https://documents.eptarefrigeration.com>.

The sound pressure level generated by the operation of the cabinet is lower than 70 dB(A). The cabinet does not cause harmful vibrations.

## 10.7 Loading the product

Energise the cabinet to start its cooling cycle, by acting on the general disconnecter switch mounted on the wall. After about 2 hours it is possible to load the cabinet.

The cabinet is suitable to maintain the temperature of the goods and not lower it; the foods, therefore, must be introduced inside it only if already cooled to the respective temperatures of preservation. Products which have been heated must never be introduced into the cabinet.

In the presence of glass fronts on the cabinet, it is recommended to load the goods when there is no customer in the sales area.

In loading the goods, ensure that:

- The load is homogeneous in terms of dimension and quality of the products.
- The goods do not obstruct the correct flow of refrigerated air ("Fig. 21")
- The goods do not exceed the load line.
- The upper part of the cabinet must not be loaded ("Fig. 25").

Uniformly distributed maximum permissible load:

- On the bottom level: 225 kg/m<sup>2</sup>
- On the shelves: 140 kg/m<sup>2</sup>
- Out of the total of shelves: MAX 420 kg/m<sup>2</sup> (3 shelves) - 560 kg/m<sup>2</sup> (4 shelves)

Modello - Modèle - Model Modell - Modelo - Modelo	<b>PROFILE</b>	 epta refrigeration
Fabbricante - Constructeur - Manufacturer Hersteller - Fabricante - Fabricante	<b>Epta Spa</b> - Via Mecenate, 86 - 20138 Milano (MI) ITALIA Tel. 02/55403211 Telefax 02/55401023	<b>28/32</b>

## 10.8 Use of cabinet



For correct operation, we recommend verifying that the doors are not open.

### Lighting

The cabinet lighting is controlled by a switch on the bottom right of the cabinet.

### Thermostat/thermometer

A remote thermostat/thermometer is positioned on the bottom right of the cabinet to control the temperature ("Fig. 2", "Fig. 3", "Fig. 4").

The remote thermostat displays the existing temperature inside the housing and the temperature is controlled using the dedicated buttons.

### Configuration and inclination of the display shelves

To ensure the correct performance that the cabinet was designed for, shelves must be arranged inside the cabinet according to specific configurations (chart "Chart III" to pg. "25").

Shelf inclination can be set on 4 different positions, by moving the shelf supporting bracket on the display case's uprights. ("Fig. 24").

Only for open model



Using night covers or night curtains, if any are installed, during closing hours. ("Fig. 22").

Only for closed model



Never leave the glass doors open or ajar. It is advisable to often check that all doors are closed: you will thus avoid unnecessary energy consumption and frost build-ups on the walls and you will also allow better food preservation.

## 10.9 Cleaning and ordinary maintenance

Good visibility in the intervention area is recommended, possibly using an additional light source.

### Cleaning the cabinet

Only use water at a maximum temperature of 65°C and household soap or neutral detergent diluted in water.

For glass surfaces use only products for cleaning glass. It is recommended to avoid the use of water since it may deposit limestone on the surface of the glass.

Never use:

- Abrasive sponges
- Flammable or abrasive products such as alcohol, acetone or solvents
- Detergents that contain non-ionic surfactants, lemon or vinegar (acetic acid)



Do not wash or clean the top part of the cabinet with water or liquids.

Clean all the external parts of the cabinet **ONCE A WEEK**.

Clean all the internal parts of the cabinet **ONCE A MONTH**, following the instructions below:

- Disconnect the power supply to the cabinet using the wall-mounted main switch-disconnector ("Fig. 29").
- Empty the cabinet, storing the goods in cold rooms or refrigerators to maintain the preservation temperature.
- Wait for the inside of the cabinet to have reached the ambient temperature and then clean
- After carefully checking that the inside of the cabinet is completely dry, restart the appliance by re-energising the cabinet.
- After a couple of hours, load the goods again.

Modello - Modèle - Model Modell - Modelo - Modelo	<b>PROFILE</b>	 epta refrigeration
Fabbricante - Constructeur - Manufacturer Hersteller - Fabricante - Fabricante	<b>Epta Spa</b> - Via Mecenate, 86 - 20138 Milano (MI) ITALIA Tel. 02/55403211 Telefax 02/55401023	<b>29/32</b>

When you put the cabinet out of service, disconnect the power and follow the passages above, leaving the doors open (if available) to avoid odours.

Defrost the cabinet **EVERY THREE MONTHS** to allow the ice to melt which may have formed on the fins of the evaporator preventing correct operation. The duration of the defrosting activity is regulated directly in the factory. Any adjustments are reserved exclusively for the technical service department. The defrosting water is collected by a special drain. Periodically check that the defrosting water drains normally. If not, intervene immediately using a non-pointed flexible probe.

Do as indicated to clean the internal parts **MONTHLY**, but in this case foresee a longer waiting time to allow the ice to melt completely.

### 10.10 Emergency situations

#### The cabinet does not start or it stops:

- Check there is no electrical blackout.
- Check that the main power switch on the wall is on.
- Check the cabinet plug is inserted into the socket.

If the power outage does not depend on these reasons, contact the nearest authorised service centre and empty completely and immediately store the product in cold rooms or refrigerators that can maintain the preservation temperature.

#### The cabinet does not cool sufficiently:

- Check that the cabinet is loading correctly.
- Defrost the cabinet and then resume normal operation, if this operation has not been carried out for more than three months.
- Check that the cabinet is not close to heat sources or air currents.
- Verify the ambient conditions; the reference values are contained in "Ambient conditions" ("Chart II", Pg."20").
- Check the flatness of the cabinet using a leveller.

If cooling failure persists, contact your nearest authorised service centre.

#### The cabinet is noisy:

- Check screws and bolts are perfectly tightened.
- Check the flatness of the cabinet using a leveller.

If the inconvenience persists, contact your nearest authorised service centre.

### 10.11 Technical assistance

Where technical assistance personnel are required, contact immediately the supplier from whom the cabinet was purchased.

If you need to use spare parts always refer to the technical assistance service: ask and ensure that original spare parts are used.

EN

IT

FR

DE

ES

PT

Modello - Modèle - Model Modell - Modelo - Modelo	<b>PROFILE</b>	 epta refrigeration
Fabbricante - Constructeur - Manufacturer Hersteller - Fabricante - Fabricante	<b>Epta Spa</b> - Via Mecenate, 86 - 20138 Milano (MI) ITALIA Tel. 02/55403211 Telefax 02/55401023	<b>30/32</b>

- EN
- IT
- FR
- DE
- ES
- PT

## 10.12 Dismantling and elimination

In accordance with the rules for dismantling waste in force in the individual Countries and to respect the environment in which we live, we ask you to separate the parts of the cabinet so that they can be disposed of separately or, if necessary, recover them appropriately. Not all parts of the cabinet are comparable to municipal solid waste with the exception of the metallic parts that, in any case, are not included in special waste for the majority of European Countries.



The refrigeration system is high pressure. Contact expert staff before disposing of it.

The components of the refrigeration circuit must not be cut and/or separated before the circuit is discharged, with the recovery of refrigerant gas by qualified personnel.

Modello - Modèle - Model Modell - Modelo - Modelo	<b>PROFILE</b>	
Fabbricante - Constructeur - Manufacturer Hersteller - Fabricante - Fabricante	<b>Epta Spa</b> - Via Mecenate, 86 - 20138 Milano (MI) ITALIA Tel. 02/55403211 Telefax 02/55401023	<b>31/32</b>

## 11. SUPPLEMENTARY GENERAL WARNINGS

### Instructions for correct installation and maintenance

The user and maintenance instructions are found in the User Manual available on the website:

[www.eptarefrigeration.com](http://www.eptarefrigeration.com).

The installation instructions dedicated to expert staff are available:

- From the service network
- In some categories of product in paper format delivered together with the product

### Product information

The product information (EPREL) is available by accessing the website <https://eprel.eptarefrigeration.com> and following the instructions provided to access the database.

### Warranty

The product is covered by warranty, under the terms of law, for a period of 12 months, unless otherwise expressly agreed by the parties.

### Professional repair services

The services are provided by our service network which can be consulted in the contacts area at the website address [www.eptarefrigeration.com](http://www.eptarefrigeration.com).

### Spare parts

The spare parts and the information for the repair of the appliance are available for at least 8 years after the product is declared out of production at the following web address: [www.epta-service.com/service](http://www.epta-service.com/service).

The log-in credentials are provided on request to send via mail to:

[servicesupport@eptarefrigeration.com](mailto:servicesupport@eptarefrigeration.com).

### Important information on food waste

It is recommended to follow attentively the instructions of preservation shown in the packages of the products and the indications provided by the food producers.

Therefore, the temperature settings must be suited to the characteristics of preservation of the food products consistently in accordance with the indications set out in our technical documentation.

Incorrect uses can result in deterioration.

### Ambient conditions

This appliance is intended to function in environments in which the temperature and humidity fall within the limits provided for in the User and maintenance manual.

### Instructions for disassembly

For disassembly activities, it is necessary to contact the professional operators.

The Epta Group, which has always been driven by a special attention for the environment, makes available the dismantling and waste treatment manuals to users, downloadable below

- Access the site [www.bonnetneve.com](http://www.bonnetneve.com)



- Access the **technical area** section of the cabinet.

Modello - Modèle - Model Modell - Modelo - Modelo	<b>PROFILE</b>	
Fabbricante - Constructeur - Manufacturer Hersteller - Fabricante - Fabricante	<b>Epta Spa</b> - Via Mecenate, 86 - 20138 Milano (MI) ITALIA Tel. 02/55403211 Telefax 02/55401023	<b>32/32</b>

## User Manual

EN  
IT  
FR  
DE  
ES  
PT

### Other information

For further and more detailed information, please refer to [www.eptarefrigeration.com](http://www.eptarefrigeration.com) and to EPREL which is accessed through the QR code here or in the energy label of the product.



### Limits of application



This cabinet is designed for the use, transport and storage of up to a maximum altitude of 2000 m above sea level.

#### Storage:

- Temperature between 15°C and 50°C
- Relative humidity between 20% and 90%
- Maximum time 6 months

#### Transport:

- Temperature between 20°C and 70°C
- Relative humidity between 20% and 90%
- Maximum time 2 months

#### Use:

The climate class of use is shown on the identification plate.

Below is an extract from the reference Standard, which clarifies the meaning of the alphanumeric characters:

Climate class	Dry bulb temperature	Relative humidity
[-]	[°C]	[%]
0	20	50
1	16	80
8	24	55
2	22	65
3	25	60
4	30	55
6	27	70
5	40	40
7	35	75

EXAMPLE Climate class 3 means 25°C / 60%R.H.

### Performance



The external environmental conditions required for the correct operation of the cabinet are indicated on the identification plate.

The performance of the cabinet is not guaranteed outside of its normal use.



The minimum temperature must not be less than 16°C.

Modello - Modèle - Model Modell - Modelo - Modelo	<b>PROFILE</b>	 epta refrigeration
Fabbricante - Constructeur - Manufacturer Hersteller - Fabricante - Fabricante	<b>Epta Spa</b> - Via Mecenate, 86 - 20138 Milano (MI) ITALIA Tel. 02/55403211 Telefax 02/55401023	<b>4/32</b>

- EN
- IT**
- FR
- DE
- ES
- PT

## SIMBOLOGIA UTILIZZATA



Simbolo divieto: vieta di effettuare determinate operazioni.



Simbolo attenzione: norme antinfortunistiche per l'operatore.



Simbolo avvertenze: esiste la possibilità di arrecare danno al banco e/o ai suoi componenti.



Simbolo nota: fornisce informazioni utili.

Modello - Modèle - Model Modell - Modelo - Modelo	<b>PROFILE</b>	 epta refrigeration
Fabbricante - Constructeur - Manufacturer Hersteller - Fabricante - Fabricante	<b>Epta Spa</b> - Via Mecenate, 86 - 20138 Milano (MI) ITALIA Tel. 02/55403211 Telefax 02/55401023	<b>5/32</b>

**INDICE**

<b>1. Introduzione</b>	<b>6</b>	<b>EN</b>
<b>2. Avvertenze di sicurezza</b>	<b>7</b>	<b>IT</b>
2.1 Avvertenze generali	7	
2.2 Avvertenze per la Manutenzione del banco	9	<b>FR</b>
2.3 Avvertenze elettriche	9	
2.4 Divieti	10	<b>DE</b>
<b>3. Descrizione generale</b>	<b>11</b>	<b>ES</b>
3.1 Sezioni	13	
<b>4. Trasporto del banco</b>	<b>19</b>	<b>PT</b>
<b>5. Condizioni ambientali</b>	<b>20</b>	
6.1 Riferimento dei modelli/designazione	21	
<b>6. Caratteristiche tecniche</b>	<b>21</b>	
<b>7. Uso del banco</b>	<b>22</b>	
<b>8. Manutenzione ordinaria</b>	<b>24</b>	
8.1 Pulizia del banco	24	
<b>9. Definizione configurazioni ripiani</b>	<b>25</b>	
<b>10. Indicazioni utente</b>	<b>26</b>	
10.1 Descrizione del banco	26	
10.2 Trasporto e movimentazione	26	
10.3 Ricezione ed immagazzinamento	26	
10.4 Installazione e condizioni ambientali	27	
10.5 Collegamento elettrico	27	
10.6 Caratteristiche tecniche	27	
10.7 Caricamento del prodotto	27	
10.8 Uso del banco	28	
10.9 Pulizia e manutenzione ordinaria	28	
10.10 Situazioni di emergenza	29	
10.11 Assistenza tecnica	29	
10.12 Smantellamento ed eliminazione	30	
<b>11. Avvertenze generali integrative</b>	<b>31</b>	

Modello - Modèle - Model Modell - Modelo - Modelo	<b>PROFILE</b>	
Fabbricante - Constructeur - Manufacturer Hersteller - Fabricante - Fabricante	<b>Epta Spa</b> - Via Mecenate, 86 - 20138 Milano (MI) ITALIA Tel. 02/55403211 Telefax 02/55401023	<b>6/32</b>

## 1. INTRODUZIONE

Si raccomanda di leggere attentamente il contenuto del presente Manuale e conservarlo unitamente al banco stesso.

Il costruttore declina ogni responsabilità per danni causati a persone o cose dovuti alla mancata osservanza delle avvertenze contenute in questo Manuale.

Il presente manuale utente è applicabile ad una famiglia di prodotti disponibili in diverse configurazioni e dimensioni; le prestazioni e specifiche di ciascun modello sono completate dalle informazioni ricavabili dalla targa dati, dalla dichiarazione CE, nonché dalla etichetta energetica e relativa scheda informativa prodotto EPREL.

Il singolo modello può avere prestazioni differenti in funzione della specifica configurazione. L'etichetta energetica e la scheda informativa prodotto sono disponibili anche su <https://eprel.eptarefrigeration.com> inserendo la matricola riportata in targa dati.



Fig. N

Il presente Manuale contiene informazioni ritenute necessarie per il buon uso e funzionamento del banco.

Al suo interno si trovano le seguenti descrizioni e informazioni:

- una descrizione funzionale del banco e di ogni sua parte
- informazioni sulla sicurezza del banco e le regole antinfortunistiche da seguire
- un corretto utilizzo del banco
- una corretta manutenzione ordinaria e programmata, comprese le operazioni di pulizia

Informazioni non contenute nel presente Manuale:

- Istruzioni di installazione

Per la corretta installazione del banco si faccia riferimento ai seguenti documenti:

- Technical Manual
- Quick Reference Instructions

Il presente Manuale è rivolto alle seguenti figure professionali:

- **OPERATORE QUALIFICATO** persona qualificata, istruita per il funzionamento, la regolazione, la pulizia e la manutenzione ordinaria del banco
- **TECNICO SPECIALIZZATO** tecnico addestrato e autorizzato dall'ente indicato nel contratto (costruttore/concessionario/distributore) a eseguire: installazione, manutenzione straordinaria, riparazione, sostituzione e revisione del banco

Le istruzioni d'uso sono disponibili anche su: [www.eptarefrigeration.com](http://www.eptarefrigeration.com).

**Fare riferimento alla dichiarazione di conformità per le normative e le certificazioni del banco.**

**Conservare sempre il libretto d'istruzione e in caso di vendita dell'apparecchio consegnarlo al nuovo proprietario.**

Modello - Modèle - Model Modell - Modelo - Modelo	<b>PROFILE</b>	 epta refrigeration
Fabbricante - Constructeur - Manufacturer Hersteller - Fabricante - Fabricante	<b>Epta Spa</b> - Via Mecenate, 86 - 20138 Milano (MI) ITALIA Tel. 02/55403211 Telefax 02/55401023	<b>7/32</b>

## 2. AVVERTENZE DI SICUREZZA

### 2.1 Avvertenze generali



La designazione dell'apparecchio è riportata a pagina "21".



Questo apparecchio è progettato per funzionare in classe climatica ambientale 3 o 4; la definizione della classe climatica ambientale è riportata a pagina "32".



Il costruttore declina ogni responsabilità per danni causati a persone o cose dovuti alla mancata osservanza delle avvertenze contenute in questo manuale. Qualsiasi persona utilizzi questo banco dovrà leggere il presente manuale d'uso.



Tutte le operazioni di movimentazione, trasporto, assemblaggio e smontaggio, durante la messa fuori servizio e durante lo smaltimento, devono essere eseguite esclusivamente da personale qualificato.



Il datore di lavoro deve istruire il personale sui rischi da infortuni, sui dispositivi predisposti per la sicurezza del personale, sui rischi di emissione di rumore e sulle regole antinfortunistiche generali previste dalle norme in vigore.



L'uso tecnico del banco è riservato a persone autorizzate e istruite alle attività; tra le attività di uso tecnico rientrano ad esempio l'accensione, le regolazioni, la pulizia e la manutenzione.



L'utilizzo del banco per scopi non tecnici, quali ad esempio l'apertura delle porte per prelevare i prodotti esposti, può essere effettuato anche da bambini di età pari o superiore a 8 anni, oppure da persone con ridotte capacità fisiche, sensoriali o mentali, o prive di esperienza e conoscenza, purché siano state adeguatamente sorvegliate o istruite sull'uso dell'apparecchio in condizioni di sicurezza e abbiano compreso i pericoli connessi.

I bambini devono essere sorvegliati affinché non giochino con l'apparecchio. La pulizia e la manutenzione non devono essere effettuate da bambini senza supervisione.



Ogni altro uso non esplicitamente indicato in questo manuale è da considerarsi pericoloso ed il costruttore non può essere ritenuto responsabile per eventuali danni derivanti da uso improprio, erroneo ed irragionevole.



Il banco deve essere utilizzato da personale dotato degli opportuni dispositivi di protezione individuali.



Istruire chiunque usi il banco sulla posizione dell'interruttore sezionatore.



È obbligatorio l'uso di guanti da lavoro.



La rimozione di protezioni o pannellature che richiedono l'uso di utensili per essere rimosse è riservata esclusivamente al personale qualificato.

EN

IT

FR

DE

ES

PT

Modello - Modèle - Model Modell - Modelo - Modelo	<b>PROFILE</b>	 epta refrigeration
Fabbricante - Constructeur - Manufacturer Hersteller - Fabricante - Fabricante	<b>Epta Spa</b> - Via Mecenate, 86 - 20138 Milano (MI) ITALIA Tel. 02/55403211 Telefax 02/55401023	<b>8/32</b>

## User Manual

EN  
IT  
FR  
DE  
ES  
PT

 Ogni intervento deve essere eseguito esclusivamente da personale qualificato e, in ogni caso, prima di ogni intervento si deve scollegare l'alimentazione elettrica del banco.

 Gli interventi sul termostato sono riservati esclusivamente al personale tecnico di assistenza.

 Per il montaggio di accessori opzionali dedicati, rivolgersi al più vicino centro di assistenza autorizzato.

 Non lasciare esposto il banco agli agenti atmosferici.

 Non utilizzare getti d'acqua diretti o indiretti sul banco.

 Non toccare il banco con mani e piedi bagnati o umidi, non usare il banco a piedi nudi.

 Prestare attenzione alle parti calde o in movimento contrassegnate con l'apposito simbolo.

 Non danneggiare il circuito refrigerante.

 Evitare fuochi o scintille all'interno dell'apparecchio.

 In caso di incendio, non usare acqua per spegnere le fiamme ma solo estintori a secco.

 Non utilizzare apparecchi elettrici all'interno degli scomparti dell'apparecchio destinati alla conservazione di alimenti freschi o congelati, se non del tipo raccomandato dal costruttore.

 Non conservare sostanze esplosive o pericolose, quali contenitori sotto pressione con propellente infiammabile, in questo apparecchio.

 Non posizionare contenitori di liquido e non versare liquidi sul banco.

 Mantenere libere da ostruzioni le aperture di ventilazione nell'involucro dell'apparecchio.

 Le informazioni relative al carico massimo ammesso per ciascun tipo di ripiano sono riportate a pagina "27".

 Non lasciare pesi sopra il tetto del banco; è opportuno evitare di poggiare le derrate non imballate direttamente sui ripiani, ma utilizzare idonei contenitori per alimenti.

Modello - Modèle - Model Modell - Modelo - Modelo	<b>PROFILE</b>	 eptarefrigeration
Fabbricante - Constructeur - Manufacturer Hersteller - Fabricante - Fabricante	<b>Epta Spa</b> - Via Mecenate, 86 - 20138 Milano (MI) ITALIA Tel. 02/55403211 Telefax 02/55401023	<b>9/32</b>

## 2.2 Avvertenze per la Manutenzione del banco

 Le operazioni di manutenzione sono riservate esclusivamente a personale autorizzato.

 L'accesso a parti elettriche e/o parti che richiedono l'utilizzo di utensili è riservato a tecnici specializzati.

 Prima di qualsiasi operazione di manutenzione e pulizia riservate all'utente, togliere tensione al banco tramite l'interruttore sezionatore generale a parete.

 Prestare attenzione alle parti calde o in movimento contrassegnate con l'apposito simbolo.

 È obbligatorio l'uso di guanti da lavoro.

 È importante rispettare il tipo e la frequenza delle ispezioni e degli interventi di manutenzione necessari per un funzionamento sicuro, inclusi gli interventi di manutenzione preventiva, come descritto nel paragrafo "Pulizia e manutenzione ordinaria" a pagina "28".

## 2.3 Avvertenze elettriche

 Accertarsi che la tensione di alimentazione corrisponda ai dati di targa del banco.

 L'installazione elettrica deve essere eseguita a regola d'arte da tecnici specializzati.

 La rimozione della copertura del quadro elettrico è riservata a tecnici specializzati.

 Conformemente alle regole di installazione, la rete di alimentazione deve includere un dispositivo per la disconnessione omnipolare, che assicuri la disconnessione completa dalla rete nelle condizioni della categoria di sovratensione III.

 L'installazione del banco deve essere effettuata secondo le istruzioni del costruttore, da personale professionalmente qualificato e conformemente alle norme sugli impianti elettrici vigenti nei singoli Paesi.

 Un'errata installazione del banco può causare danni a persone, animali o cose, nei confronti dei quali il costruttore non può essere considerato responsabile.

 Se il cavo di alimentazione è danneggiato, deve essere sostituito da personale di assistenza autorizzato per evitare qualsiasi pericolo. Non tentare di riparare il cavo.

 Non alimentare il banco se è danneggiato. In caso di dubbi, contattare il servizio di assistenza o il rivenditore.

EN

IT

FR

DE

ES

PT

Modello - Modèle - Model Modell - Modelo - Modelo	<b>PROFILE</b>	 <small>epta refrigeration</small>
Fabbricante - Constructeur - Manufacturer Hersteller - Fabricante - Fabricante	<b>Epta Spa</b> - Via Mecenate, 86 - 20138 Milano (MI) ITALIA Tel. 02/55403211 Telefax 02/55401023	<b>10/32</b>

## 2.4 Divieti

- EN
- IT
- FR
- DE
- ES
- PT

 È fatto divieto di utilizzare dispositivi oltre a quelli forniti nel banco dal produttore, per accelerare il processo di sbrinamento.

 È fatto divieto, da parte di personale non specializzato, di rimuovere la copertura del quadro elettrico o aprire pannellature che richiedano l'utilizzo di utensili.

 È fatto divieto di utilizzare il banco per la conservazione e/o l'esposizione di sostanze esplosive, infiammabili o corrosive, come ad esempio bombolette spray con un propellente infiammabile.

 È fatto divieto di utilizzare il banco per la conservazione e/o l'esposizione di prodotti farmaceutici.

 È fatto divieto di collocare il banco in ambienti in cui sono presenti sostanze gassose esplosive.

 È fatto divieto di rimuovere la targa matricolare del banco.

 È fatto divieto di salire sul banco o sul batticarrello del banco.

 È fatto divieto di sostituzione di componenti e/o modifica del banco al di fuori delle specifiche previste dal costruttore, sostituzione di ricambi originali con altri non omologati dal costruttore, pena la decadenza delle condizioni di garanzia.

Modello - Modèle - Model Modell - Modelo - Modelo	<b>PROFILE</b>	 eptarefrigeration
Fabbricante - Constructeur - Manufacturer Hersteller - Fabricante - Fabricante	<b>Epta Spa</b> - Via Mecenate, 86 - 20138 Milano (MI) ITALIA Tel. 02/55403211 Telefax 02/55401023	<b>11/32</b>

### 3. DESCRIZIONE GENERALE

Aperto



Fig. 2

1. Targa dati
2. Illuminazione superiore
3. Tende notte
4. Ripiani
5. Vetri laterali
6. Interruttore luce
7. Teletermostato

Chiuso (Porte in vetro)



Fig. 3

1. Targa dati
2. Illuminazione superiore
3. Porte in vetro
4. Ripiani
5. Vetri laterali
6. Interruttore luce
7. Teletermostato

EN

IT

FR

DE

ES

PT

Modello - Modèle - Model Modell - Modelo - Modelo	<b>PROFILE</b>	 epta refrigeration
Fabbricante - Constructeur - Manufacturer Hersteller - Fabricante - Fabricante	<b>Epta Spa</b> - Via Mecenate, 86 - 20138 Milano (MI) ITALIA Tel. 02/55403211 Telefax 02/55401023	<b>12/32</b>

## User Manual

### EN Chiuso (Porte scorrevoli in vetro)

EN

IT

FR

DE

ES

PT



1. Targa dati
2. Illuminazione superiore
3. Porte scorrevoli in vetro
4. Ripiani
5. Vetri laterali
6. Interruttore luce
7. Teletermostato



Modello - Modèle - Model Modell - Modelo - Modelo	<b>PROFILE</b>	 epta refrigeration
Fabbricante - Constructeur - Manufacturer Hersteller - Fabricante - Fabricante	<b>Epta Spa</b> - Via Mecenate, 86 - 20138 Milano (MI) ITALIA Tel. 02/55403211 Telefax 02/55401023	<b>14/32</b>

User Manual

- EN
- IT
- FR
- DE
- ES
- PT

### H20Chiuso (Porte in vetro)

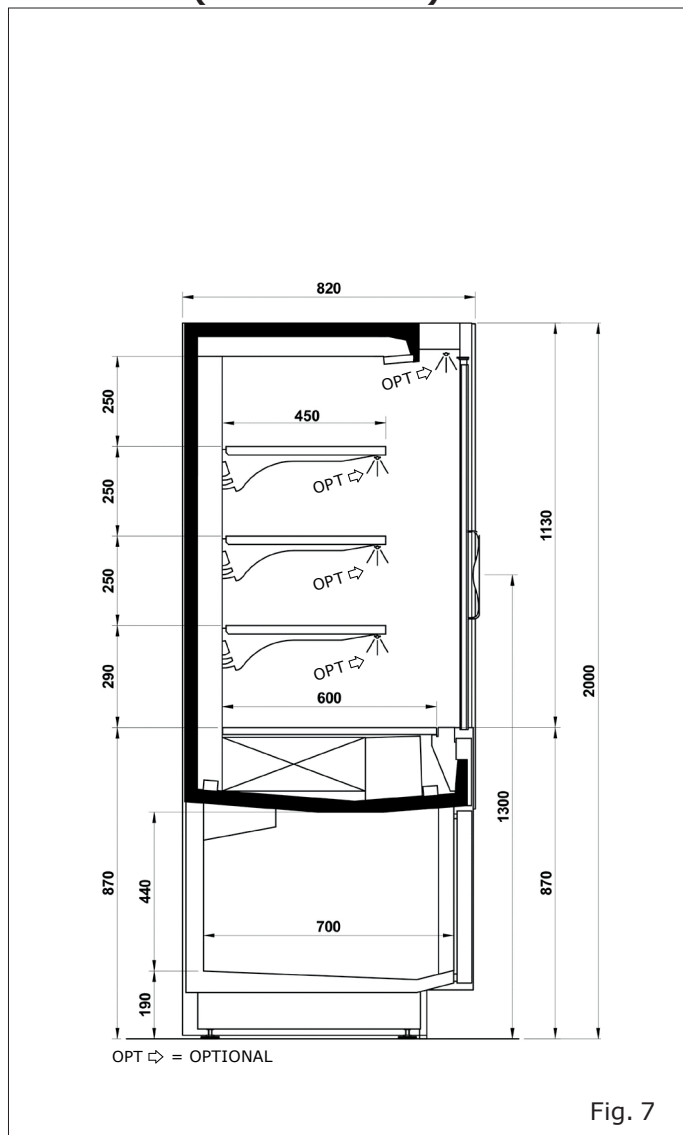

### H20Chiuso con ganci (Porte in vetro)

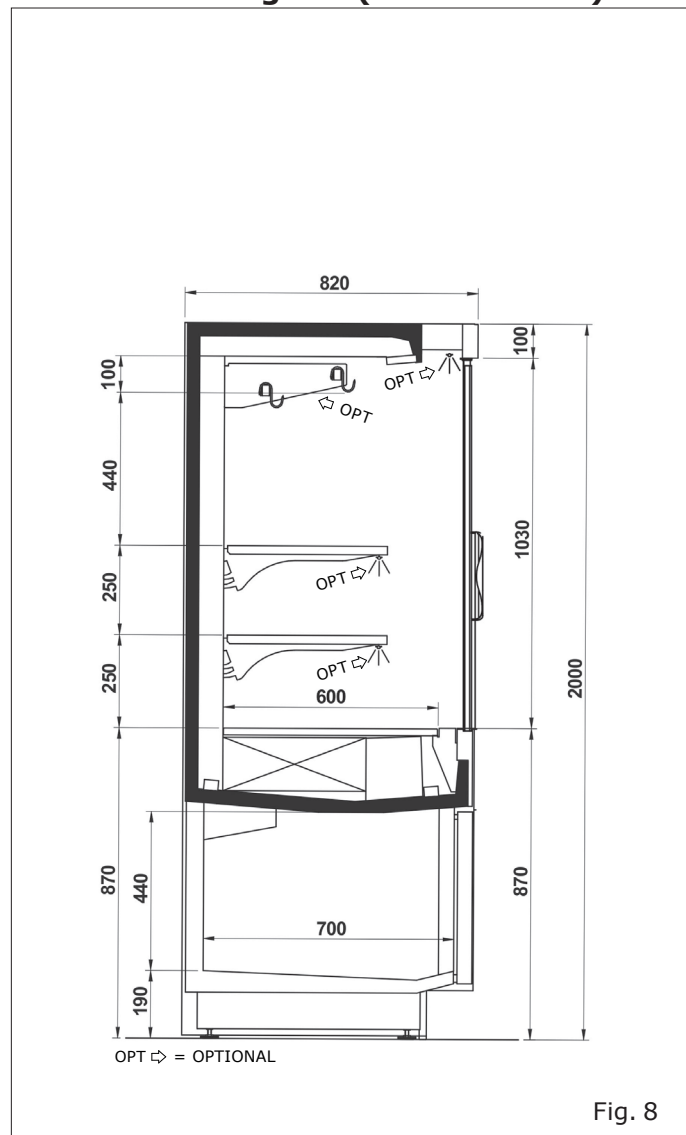

Modello - Modèle - Model Modell - Modelo - Modelo	<h1>PROFILE</h1>	
Fabbricante - Constructeur - Manufacturer Hersteller - Fabricante - Fabricante	<b>Epta Spa</b> - Via Mecenate, 86 - 20138 Milano (MI) ITALIA Tel. 02/55403211 Telefax 02/55401023	<b>15/32</b>

## H20Chiuso (Porte scorrevoli in vetro)

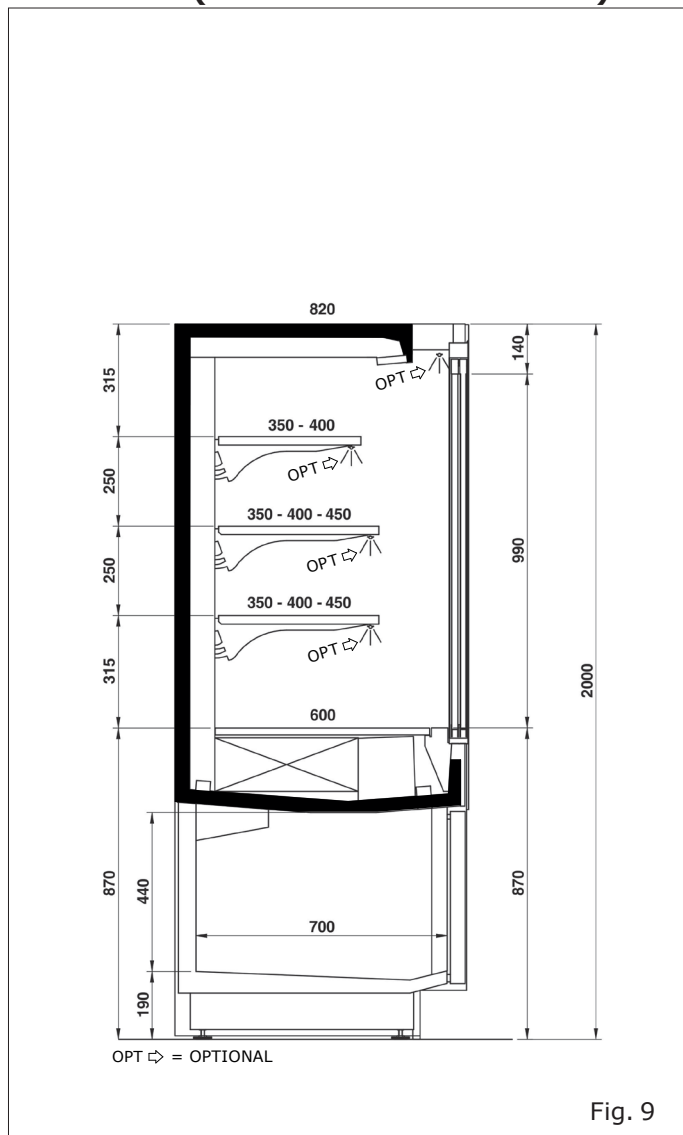

## H22Aperto

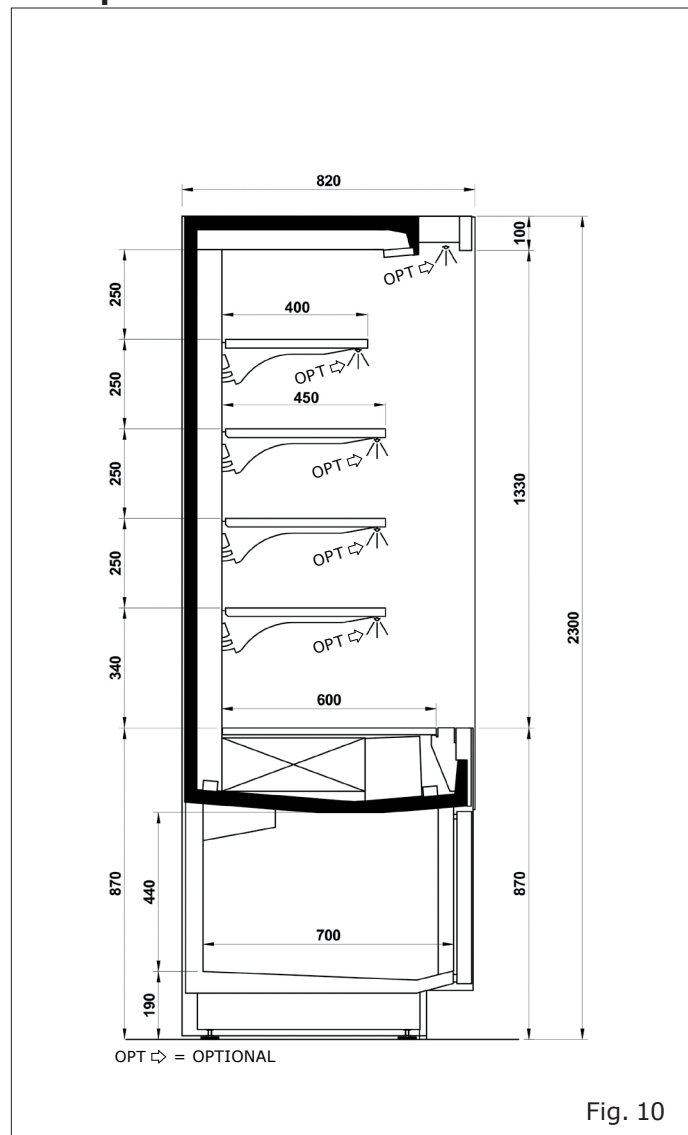

EN

IT

FR

DE

ES

PT

Modello - Modèle - Model Modell - Modelo - Modelo	<b>PROFILE</b>	
Fabbricante - Constructeur - Manufacturer Hersteller - Fabricante - Fabricante	<b>Epta Spa</b> - Via Mecenate, 86 - 20138 Milano (MI) ITALIA Tel. 02/55403211 Telefax 02/55401023	<b>16/32</b>

User Manual

- EN
- IT
- FR
- DE
- ES
- PT

**H22Aperto con ganci**

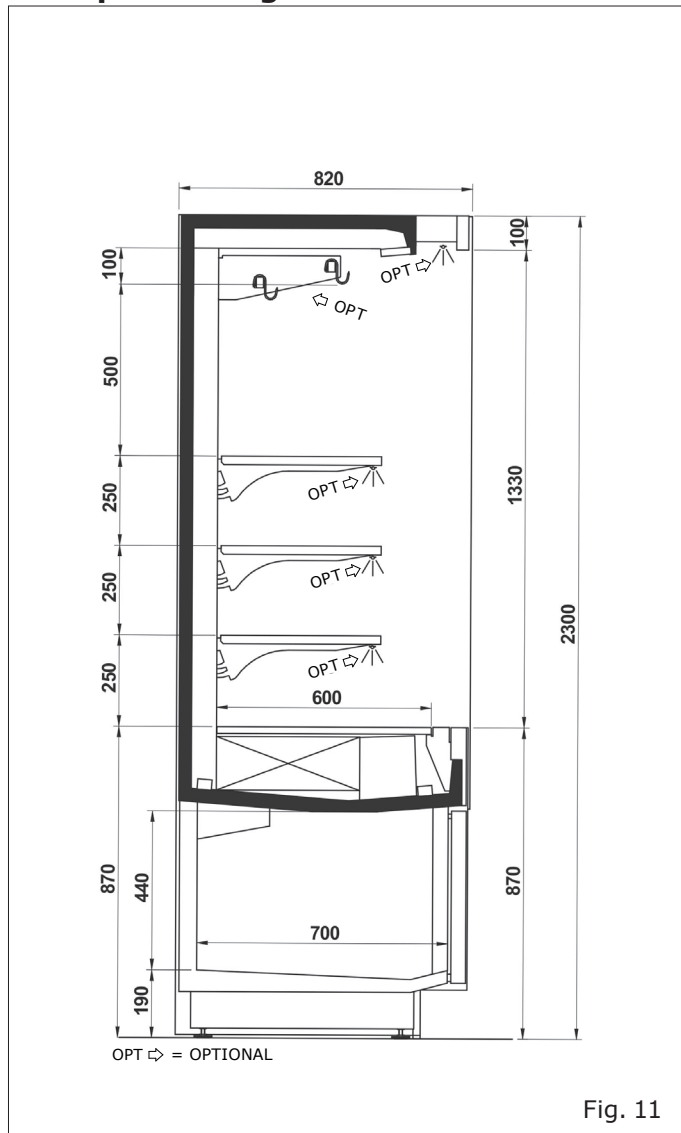

**H22Chiuso (Porte in vetro)**

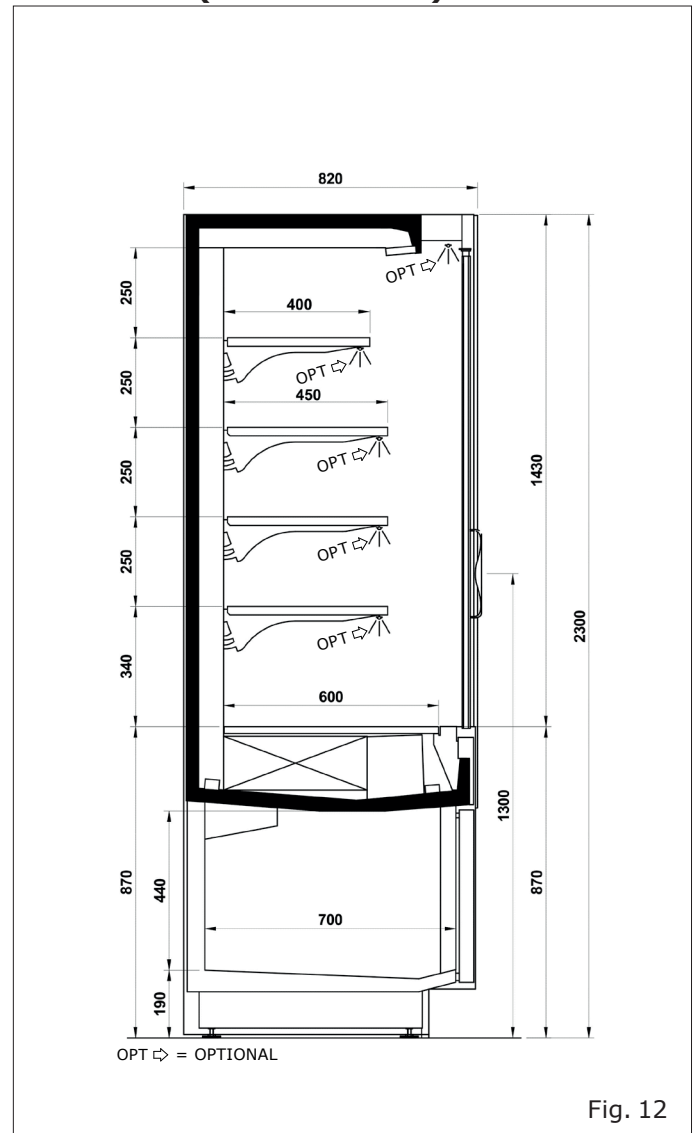

Modello - Modèle - Model Modell - Modelo - Modelo	<b>PROFILE</b>	
Fabbricante - Constructeur - Manufacturer Hersteller - Fabricante - Fabricante	<b>Epta Spa</b> - Via Mecenate, 86 - 20138 Milano (MI) ITALIA Tel. 02/55403211 Telefax 02/55401023	<b>17/32</b>

### H22Chiuso con ganci (Porte in vetro)

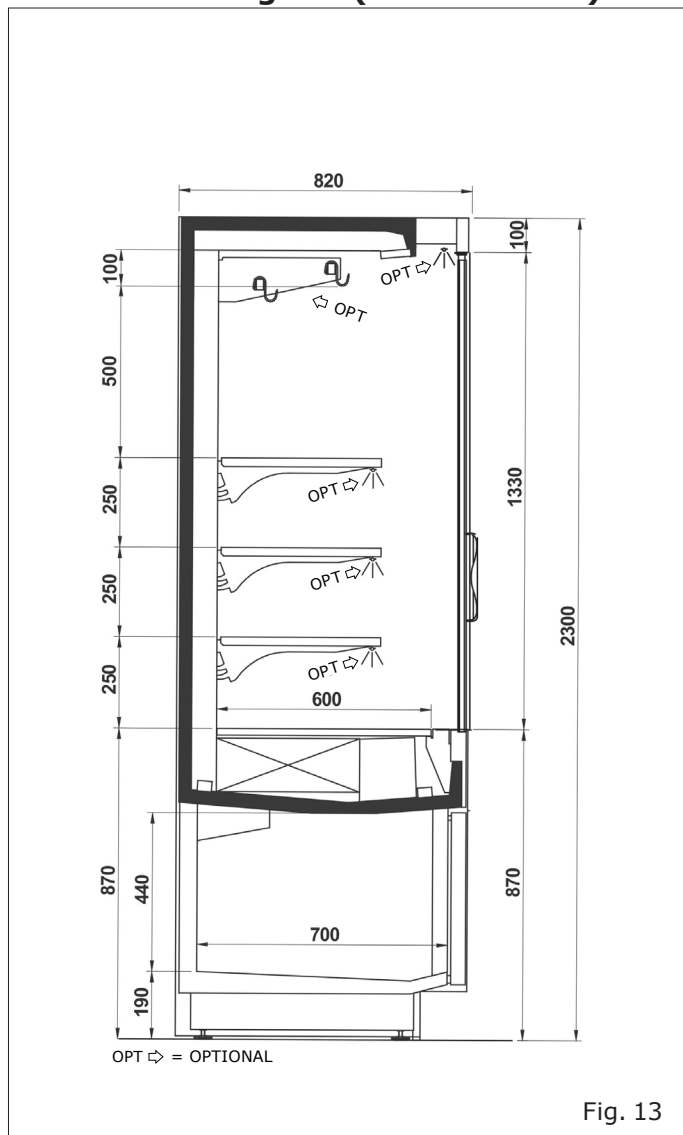

### H22Chiuso (Porte scorrevoli in vetro)

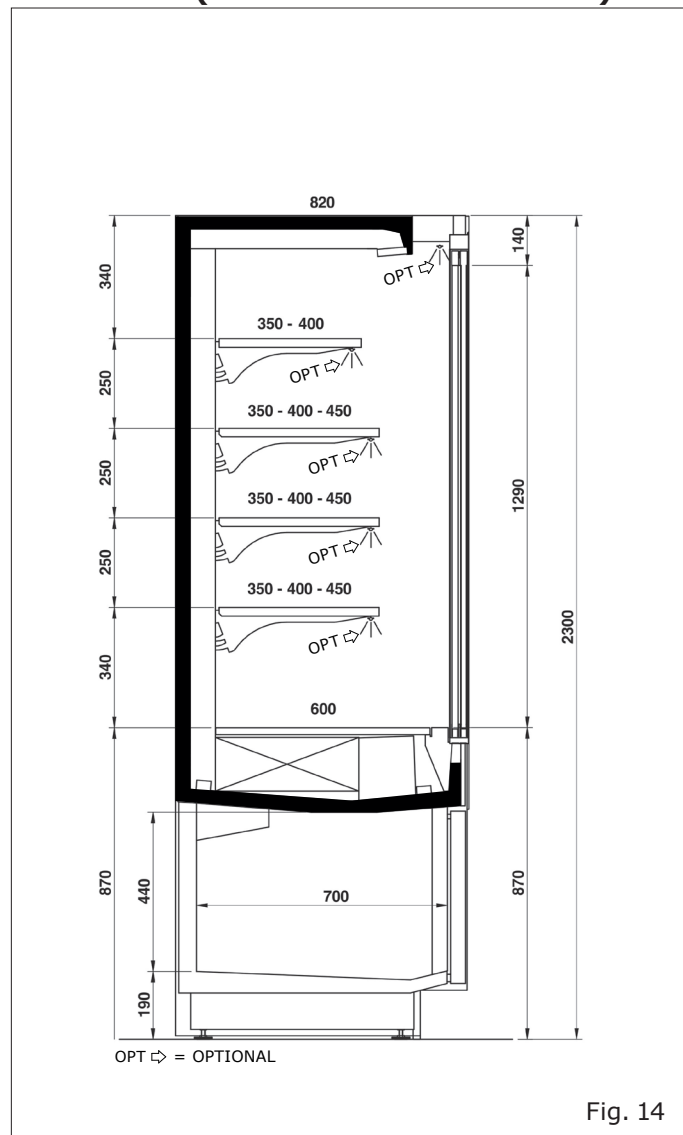

- EN
- IT**
- FR
- DE
- ES
- PT

Modello - Modèle - Model Modell - Modelo - Modelo	<h1>PROFILE</h1>	 eptarefrigeration
Fabbricante - Constructeur - Manufacturer Hersteller - Fabricante - Fabricante	<b>Epta Spa</b> - Via Mecenate, 86 - 20138 Milano (MI) ITALIA Tel. 02/55403211 Telefax 02/55401023	<b>18/32</b>

User Manual

- EN
- IT
- FR
- DE
- ES
- PT

## H26Aperto

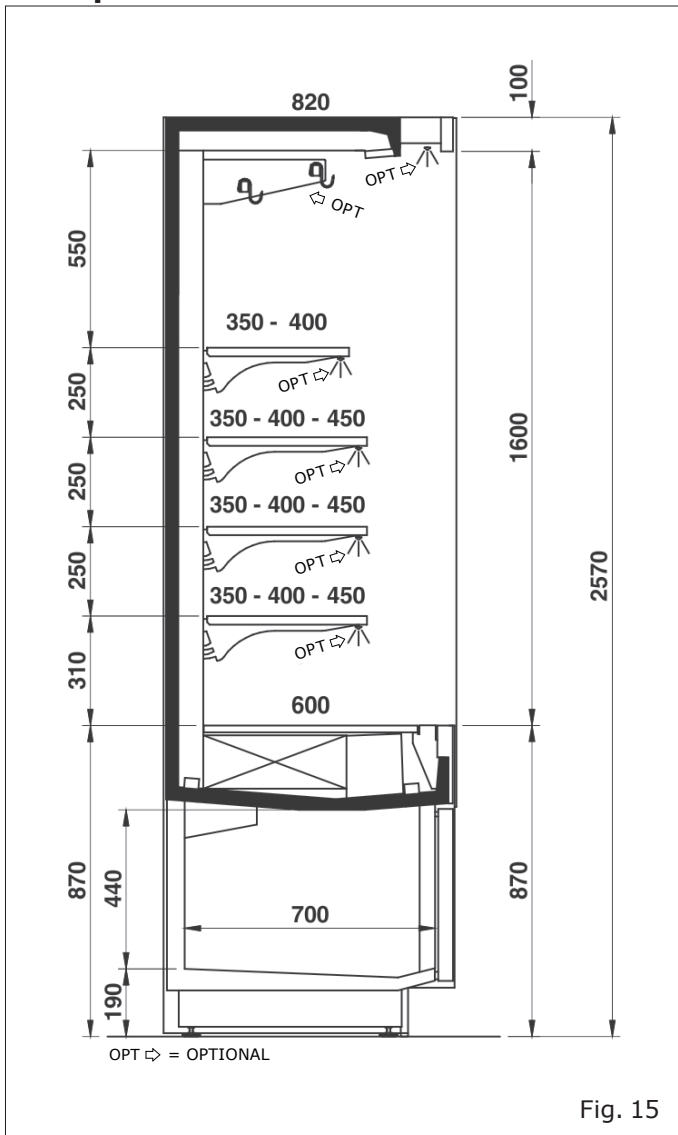

Modello - Modèle - Model Modell - Modelo - Modelo	<b>PROFILE</b>	 epta refrigeration
Fabbricante - Constructeur - Manufacturer Hersteller - Fabricante - Fabricante	<b>Epta Spa</b> - Via Mecenate, 86 - 20138 Milano (MI) ITALIA Tel. 02/55403211 Telefax 02/55401023	<b>19/32</b>

## 4. TRASPORTO DEL BANCO



### 1. Punti di sollevamento

**Tab. I**

Altezza	Lunghezza	Peso (kg)	Peso con imballo (kg)
2000	1250	85	95
	1875	215	240
	2500	365	400
2300	1250	100	120
	1875	250	280
	2500	400	440
2500	1250	115	135
	1875	285	315
	2500	435	475

Modello - Modèle - Model Modell - Modelo - Modelo	<b>PROFILE</b>	
Fabbricante - Constructeur - Manufacturer Hersteller - Fabricante - Fabricante	<b>Epta Spa</b> - Via Mecenate, 86 - 20138 Milano (MI) ITALIA Tel. 02/55403211 Telefax 02/55401023	<b>20/32</b>

EN

IT

FR

DE

ES

PT

## 5. CONDIZIONI AMBIENTALI



**Tab. II**

Caratteristiche	
Tipo di locale	Chiuso
Temperatura	25°C
Umidità relativa	60 %
Illuminazione	600 lx



Modello - Modèle - Model Modell - Modelo - Modelo	<b>PROFILE</b>	 epta refrigeration
Fabbricante - Constructeur - Manufacturer Hersteller - Fabricante - Fabricante	<b>Epta Spa</b> - Via Mecenate, 86 - 20138 Milano (MI) ITALIA Tel. 02/55403211 Telefax 02/55401023	<b>21/32</b>

## 6. CARATTERISTICHE TECNICHE



































 <small>EPTA S.p.A. Via Mecenate, 86 20138 Milano - Italy</small>			
			
<b>RATED</b> <b>BEMESSUNG</b> <b>ASSIGNÉ</b> <b>NOMINALE</b> <b>NOMINAL</b>			<b>REFRIGERANT</b> <b>KÄLTEMITTEL</b> <b>RÉFRIGÉRANT</b> <b>REFRIGÉRANTE</b> <b>REFRIGERANTE</b>
			
<b>DEFROSTING</b> <b>ABTAUUNG</b> <b>DÉGIVRAGE</b> <b>SBRINAMENTO</b> <b>DESCONGELAMIENTO</b>		<b>CLIMATIC CLASS</b> <b>KLIMAKLASSE</b> <b>CLASSE CLIMATIQUE</b> <b>CLASSE CLIMATICA</b> <b>CLASE CLIMÁTICA</b>	
		<b>INSULATION BLOWING GAS</b> <b>ISOLATIONS GAS (BLÄHGAS)</b> <b>AGENT MOUSSANT D'ISOLATION</b> <b>GAS ESPANDENTE ISOLAMENTO</b> <b>AGENTE ESPUMANTE</b>	
		<b>PROTECTION INDEX</b> <b>SCHÜTZART</b> <b>INDEX DE LA PROTECTION</b> <b>INDICE DI PROTEZIONE</b> <b>ÍNDICE DE PROTECCIÓN</b>	
			
		  	
			
			
			
			
			
			

Fig. 20

- |  |   |
|--|---|
| <ol style="list-style-type: none"> <li>1. Origine del prodotto</li> <li>2. Prodotto in "Paese di origine"</li> <li>3. Tensione nominale</li> <li>4. Potenza nominale</li> <li>5. Frequenza nominale</li> <li>6. Corrente Nominale</li> <li>7. Potenza di sbrinamento</li> <li>8. Corrente di sbrinamento</li> <li>9. Sistema di riscaldamento</li> <li>10. Sistema di illuminazione</li> <li>11. Manuale dell'operatore</li> <li>12. Codice a barre</li> </ol> | <ol style="list-style-type: none"> <li>13. Numero di serie</li> <li>14. Data di produzione</li> <li>15. Hat Code</li> <li>16. Modello/designazione</li> <li>17. Tipo di refrigerante 1</li> <li>18. Massa refrigerante 1</li> <li>19. Tipo di refrigerante 2</li> <li>20. Massa refrigerante 2</li> <li>21. Classe climatica</li> <li>22. Isolamento gas</li> <li>23. Indice di protezione</li> <li>24. Marchi di certificazione</li> </ol> |
|--|---|

### 6.1 Riferimento dei modelli/designazione

La tabella spiega come leggere il codice modello, indicando le informazioni commerciali rilevanti per ciascuna parte del riferimento (vedere campo etichetta numero: "16").

#### PROFILE xxx (Banco refrigerato)

Riferimento/designazione	Descrizione	Informazioni commerciali
Profile	Nome	Profile
xxx	Lunghezza	125(1250), 188(1875), 250(2500)

esempio:

Profile125 = Profile 1250

Modello - Modèle - Model Modell - Modelo - Modelo	<b>PROFILE</b>	
Fabbricante - Constructeur - Manufacturer Hersteller - Fabricante - Fabricante	<b>Epta Spa</b> - Via Mecenate, 86 - 20138 Milano (MI) ITALIA Tel. 02/55403211 Telefax 02/55401023	<b>22/32</b>

EN

IT

FR

DE

ES

PT

## 7. USO DEL BANCO



 Non coprire

Solo per modello aperto

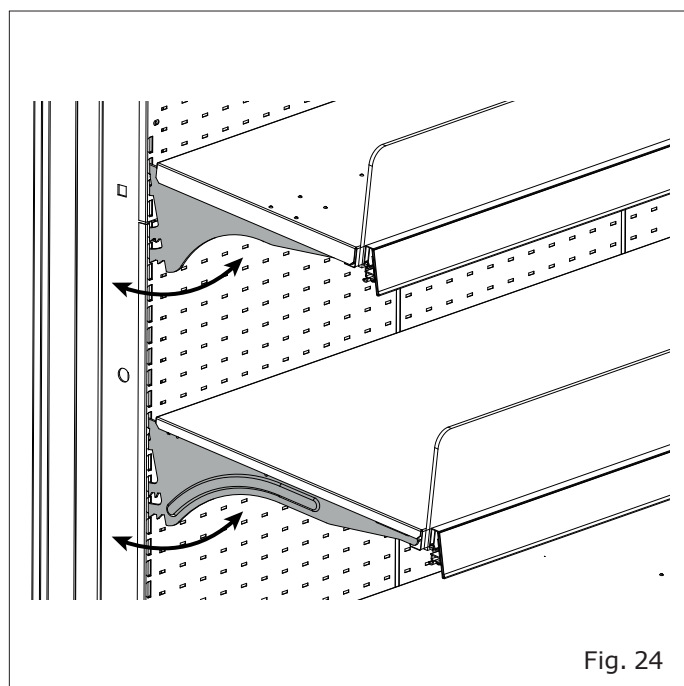

Inclinazione ripiani: 0° - 7° - 14° - 21°

Modello - Modèle - Model Modell - Modelo - Modelo	<h1>PROFILE</h1>	
Fabbricante - Constructeur - Manufacturer Hersteller - Fabricante - Fabricante	<b>Epta Spa</b> - Via Mecenate, 86 - 20138 Milano (MI) ITALIA Tel. 02/55403211 Telefax 02/55401023	<b>23/32</b>



- EN
- IT**
- FR
- DE
- ES
- PT

Modello - Modèle - Model Modell - Modelo - Modelo	<b>PROFILE</b>	
Fabbricante - Constructeur - Manufacturer Hersteller - Fabricante - Fabricante	<b>Epta Spa</b> - Via Mecenate, 86 - 20138 Milano (MI) ITALIA Tel. 02/55403211 Telefax 02/55401023	<b>24/32</b>

EN

## 8. MANUTENZIONE ORDINARIA

IT

### 8.1 Pulizia del banco

FR

DE

ES

PT

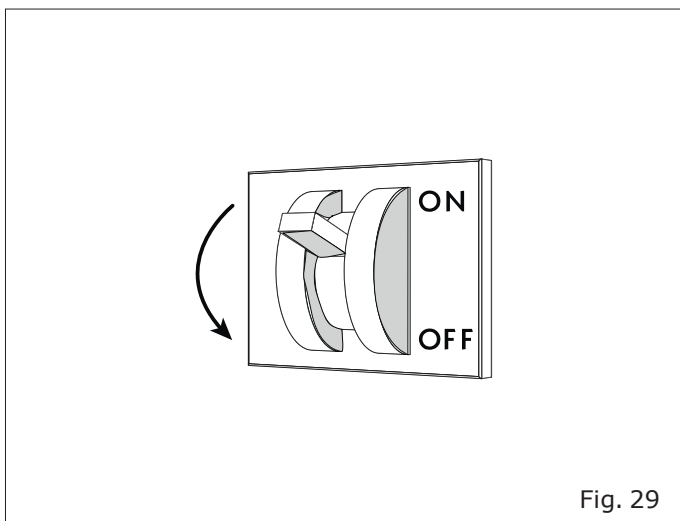

Modello - Modèle - Model Modell - Modelo - Modelo	<b>PROFILE</b>	 epta refrigeration
Fabbricante - Constructeur - Manufacturer Hersteller - Fabricante - Fabricante	<b>Epta Spa</b> - Via Mecenate, 86 - 20138 Milano (MI) ITALIA Tel. 02/55403211 Telefax 02/55401023	<b>25/32</b>

## 9. DEFINIZIONE CONFIGURAZIONI RIPIANI

Tab. III

Configurazione ripiani singola profondità			
Livello	Con agganci	Senza agganci	H20
1	x	x	350-400-450 350-400-450
2	x	x	350-400-450 350-400-451
3	x	-	350-400-450 350-400-452

Configurazione ripiani singola profondità			
Livello	Con agganci	Senza agganci	H23
1	x	x	350-400-450 350-400-450
2	x	x	350-400-450 350-400-451
3	x	x	350-400-450 350-400-452
4	x	-	350-400-450 350-400-453

Modello - Modèle - Model Modell - Modelo - Modelo	<b>PROFILE</b>	
Fabbricante - Constructeur - Manufacturer Hersteller - Fabricante - Fabricante	<b>Epta Spa</b> - Via Mecenate, 86 - 20138 Milano (MI) ITALIA Tel. 02/55403211 Telefax 02/55401023	<b>26/32</b>

## 10. INDICAZIONI UTENTE

### 10.1 Descrizione del banco

Questa linea di banchi è adatta alla conservazione ed esposizione di derrate alimentari fresche, preconfezionate, bibite e latticini.

CLASSE DI TEMPERATURA (secondo EN ISO 23953-2):

- Aperto H20/H23: 3M1/3M2, H26: 3M2
- Chiuso H20/H23/H26: 3M1

Le caratteristiche generali e le dimensioni sono illustrate nelle figure e nelle sezioni contenute in "Descrizione generale" (da pag. "11" a pag. "18").

L'impostazione consigliata delle temperature in ogni scomparto per la conservazione ottimale degli alimenti è indicata nella scheda informativa del prodotto che è disponibile in EPREL oppure collegandosi al sito <https://eprel.eptarefrigeration.com> e seguendo le istruzioni riportate per l'accesso al database.

Durante le fasi di trasporto e movimentazione, ricezione e immagazzinamento, installazione, caricamento, uso, pulizia e manutenzione, smantellamento, prestare attenzione al rischio di ribaltamento del banco ("Fig. 31").

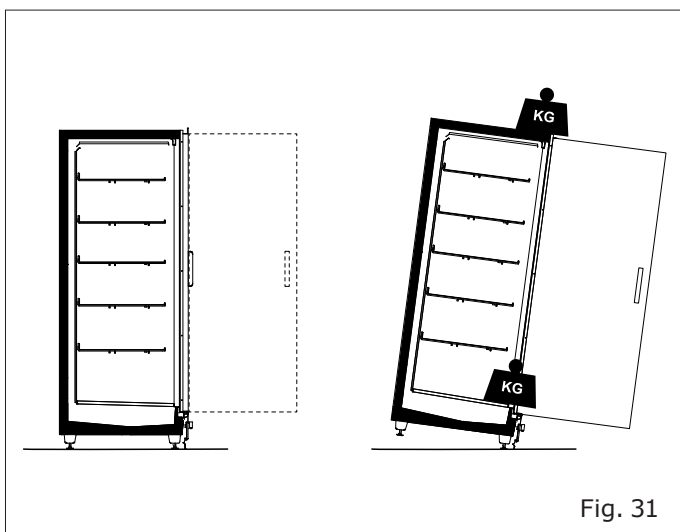

Fig. 31

### 10.2 Trasporto e movimentazione

Il banco è contenuto in uno specifico imballo provvisto di pedana per la movimentazione con carrelli a forca.

Per il trasporto e la movimentazione del banco utilizzare:

- Esclusivamente una pedana apposita o equivalente
- Un carrello elevatore a mano o elettrico adatto al sollevamento del banco, con caratteristiche idonee nel rispetto delle Norme vigenti

I pesi del banco (vuoto e con imballo) e le dimensioni dell'imballo sono riportati in "Trasporto del banco" (tabella "Tab. I" e figure a pag. "19").

Le operazioni di movimentazione devono essere svolte da personale qualificato, in grado di valutare pesi, punti di sollevamento e mezzi più idonei sia per sicurezza che per portata.

### 10.3 Ricezione ed immagazzinamento

Controllare le condizioni dell'imballo prima di prendere in consegna il banco dal trasportatore. Se ci sono danni evidenti nell'imballo:

- Rimuovere l'imballo del banco in presenza del trasportatore.
- Firmare con riserva il documento di consegna.

Il costruttore non risponde di eventuali danni dovuti al trasporto o ad un errato stoccaggio del banco.

Il banco deve essere conservato in un luogo riparato da sole ed intemperie, con una temperatura compresa tra -25°C e +55°C e un'umidità relativa dell'aria compresa tra 30% e 95%.

Modello - Modèle - Model Modell - Modelo - Modelo	<b>PROFILE</b>	
Fabbricante - Constructeur - Manufacturer Hersteller - Fabricante - Fabricante	<b>Epta Spa</b> - Via Mecenate, 86 - 20138 Milano (MI) ITALIA Tel. 02/55403211 Telefax 02/55401023	<b>27/32</b>

## 10.4 Installazione e condizioni ambientali

Il banco non è progettato per un'installazione da esterno.

Per un corretto funzionamento del banco, verificare che sia posizionato:

- Su un pavimento livellato ("Fig. 18").
- Lontano da fonti di calore, dalla radiazione diretta del sole, da porte, finestre, ventilatori e bocche di aerazione ("Fig. 19").

Assicurare lo spazio necessario all'uso del banco da parte della clientela.

Le condizioni dell'ambiente in cui porre il banco sono riportate in: "Condizioni ambientali" (tabella "Tab. II", Pag."20").

## 10.5 Collegamento elettrico

A monte del banco deve essere installato un interruttore sezionatore omipolare. Questo deve avere potere di interruzione adeguato.

L'interruttore sezionatore deve essere posto a monte del banco e deve essere visibile dall'operatore durante le fasi di pulizia e manutenzione o provvisto di disinserimento con sistema di bloccaggio in posizione isolata.

Prima di collegare il banco, accertarsi che la tensione di alimentazione corrisponda ai dati di targa del banco. Per garantire un funzionamento regolare, la variazione massima di tensione deve essere compresa tra +/- 6% del valore nominale.

## 10.6 Caratteristiche tecniche

La targa matricolare riporta i dati tecnici caratteristici del banco. La sua posizione e la tipologia di dati sono riportati in: "Caratteristiche tecniche" ("Fig. 20").

Schemi elettrici, distinte di taratura degli strumenti di controllo, istruzioni di Installazione e copia della Dichiarazione di Conformità sono disponibili sul sito <https://documents.eptarefrigeration.com>.

Il livello di pressione sonora generato dal funzionamento del banco è inferiore a 70 dB(A). Il banco non provoca vibrazioni dannose.

## 10.7 Caricamento del prodotto

Dare tensione al banco per dare inizio al suo ciclo di raffreddamento, agendo sull'interruttore sezionatore generale a parete. Dopo circa 2 ore è possibile caricare il banco.

Il banco è atto a conservare la temperatura della merce e non ad abbatterla; le derrate, quindi, devono essere introdotte al suo interno solo se già raffreddate alle loro rispettive temperature di conservazione. Prodotti che abbiano subito un riscaldamento non devono mai essere introdotti nel banco.

In presenza di vetri frontali sul banco, si consiglia di effettuare il caricamento della merce quando nello spazio di vendita non è presente la clientela.

Nel caricamento della merce, fare in modo che:

- Il carico sia omogeneo per dimensione e qualità della merce stessa.
- La merce non ostruisca il corretto flusso d'aria refrigerata ("Fig. 21")
- La merce non superi la linea di carico.
- La parte superiore del banco non sia caricata ("Fig. 25").

Carico massimo ammissibile uniformemente distribuito:

- Sul piano di fondo: 225 kg/m<sup>2</sup>
- Sui ripiani: 140 kg/m<sup>2</sup>
- Sul totale dei ripiani: MAX 420 kg/m<sup>2</sup> (3 ripiani) - 560 kg/m<sup>2</sup> (4 ripiani)

Modello - Modèle - Model Modell - Modelo - Modelo	<b>PROFILE</b>	 epta refrigeration
Fabbricante - Constructeur - Manufacturer Hersteller - Fabricante - Fabricante	<b>Epta Spa</b> - Via Mecenate, 86 - 20138 Milano (MI) ITALIA Tel. 02/55403211 Telefax 02/55401023	<b>28/32</b>

## 10.8 Uso del banco



Per un miglior funzionamento del banco, si raccomanda che le porte non rimangano aperte.

### Illuminazione

L'illuminazione del banco è comandata da un interruttore posto sul banco in basso a destra.

### Termostato/termometro

Sul banco in basso a destra è posizionato un termostato/termometro remoto per il controllo della temperatura ("Fig. 2", "Fig. 3", "Fig. 4"). Il termostato remoto visualizza la temperatura esistente all'interno della custodia e permette il controllo della temperatura tramite gli appositi tasti.

### Configurazione e inclinazione dei ripiani espositivi

Per garantire le prestazioni corrette per le quali il banco è stato concepito, la disposizione dei ripiani all'interno del banco deve rispettare delle precise configurazioni (tabella "Tab. III" a pag. "25").

Variando la posizione di aggancio dei ripiani con i montanti posteriori del banco, sono consentite 4 diverse inclinazioni ("Fig. 24").

Solo per modello aperto



Usare i coperchi notte o le tendine notte, se previsti, durante le ore di chiusura. ("Fig. 22").

Solo per modello chiuso



Non lasciare mai aperte o socchiuse le porte in vetro. Si raccomanda di verificare frequentemente che tutti le porte siano chiuse: eviterete inutili consumi di energia e formazioni di brina sulle pareti ottenendo nel contempo una migliore conservazione dei prodotti esposti.

## 10.9 Pulizia e manutenzione ordinaria

Si consiglia una buona visibilità nella zona di intervento, eventualmente servendosi di una ulteriore fonte di illuminazione.

### Pulizia del banco

Utilizzare esclusivamente acqua a temperatura massima di 65°C e sapone o detergente neutro di uso domestico diluito in acqua.

Per le superfici vetrate usare unicamente prodotti per la pulizia dei vetri. Si consiglia di evitare l'uso di acqua in quanto può depositare calcare sulla superficie del vetro.

Non utilizzare assolutamente:

- Spugne abrasive
- Prodotti infiammabili o abrasivi come alcool, acetone o solventi
- Detergenti che contengono tensioattivi non ionici, limone o aceto (acido acetico)



Non lavare o pulire con acqua o liquidi la parte superiore del banco.

Pulire **UNA VOLTA A SETTIMANA** tutte le parti esterne del banco.

Pulire **UNA VOLTA AL MESE** tutte le parti interne del banco, seguendo le istruzioni sotto riportate:

- Togliere la tensione elettrica al banco tramite l'interruttore sezionatore generale a parete ("Fig. 29").
- Svuotare il banco, stoccando la merce in celle o refrigeratori atti a mantenerne la temperatura di conservazione.
- Attendere che l'interno del banco abbia raggiunto la temperatura ambiente e procedere alla pulizia
- Dopo aver controllato attentamente che l'interno del banco sia completamente asciutto, rimettere in funzione l'apparecchio ridando tensione al banco.
- Dopo circa un paio d'ore caricare nuovamente la merce.

Modello - Modèle - Model Modell - Modelo - Modelo	<b>PROFILE</b>	 epta refrigeration
Fabbricante - Constructeur - Manufacturer Hersteller - Fabricante - Fabricante	<b>Epta Spa</b> - Via Mecenate, 86 - 20138 Milano (MI) ITALIA Tel. 02/55403211 Telefax 02/55401023	<b>29/32</b>

Quando si mette fuori servizio il banco, scollegare l'alimentazione e seguire i passaggi precedenti, lasciando gli sportelli aperti (se presenti) per evitare cattivi odori.

Procedere **OGNI TRE MESI** allo sbrinamento del banco per permettere lo scioglimento del ghiaccio che si può essere formato sulle alette dell'evaporatore impedendone il corretto funzionamento. La durata e il numero di sbrinamenti sono regolati direttamente in fabbrica. Eventuali regolazioni sono riservate esclusivamente al servizio tecnico di assistenza. L'acqua di sbrinamento viene raccolta da un apposito scarico. Verificare periodicamente che l'acqua di sbrinamento defluisca normalmente. Se così non fosse intervenire mediante una sonda flessibile non appuntita.

Agire come indicato per la pulizia **MENSILE** delle parti interne, ma in questo caso si dovrà prevedere un tempo di attesa più lungo per permettere il completo scioglimento del ghiaccio.

### 10.10 Situazioni di emergenza

#### Il banco non parte o si arresta:

- Verificare che non vi sia una situazione di blackout elettrico.
- Controllare che l'interruttore generale a parete sia acceso.
- Controllare che la spina del banco sia inserita nella presa di corrente.

Se l'interruzione elettrica non dipende da questi motivi, rivolgersi al più vicino centro di assistenza autorizzato e procedere allo svuotamento completo ed allo stoccaggio immediato del prodotto in celle o refrigeratori atti a mantenerne la temperatura di conservazione.

#### Il banco non raffredda a sufficienza:

- Controllare che il caricamento del banco sia corretto.
- Sbrinare il banco per poi riprendere il funzionamento normale, se questa operazione non viene effettuata da più di tre mesi.
- Controllare che il banco non sia vicino a fonti di calore o correnti d'aria.
- Verificare le condizioni ambientali riportate in "Condizioni ambientali" ("Tab. II", Pag."20").
- Controllare, tramite una livella, la planarità del banco.

Se il mancato raffreddamento persiste, rivolgersi al più vicino centro di assistenza autorizzato.

#### Il banco è rumoroso:

- Controllare che viti e bulloni siano perfettamente chiusi.
- Controllare, tramite una livella, la planarità del banco.

Se l'inconveniente persiste, rivolgersi al più vicino centro di assistenza autorizzato.

### 10.11 Assistenza tecnica

Qualora si rendesse necessario l'intervento del personale tecnico di assistenza, contattare immediatamente il fornitore presso il quale è stato acquistato il banco.

Qualora vi fosse la necessità di usare pezzi di ricambio fare sempre riferimento al servizio tecnico di assistenza: chiedere ed accertarsi che vengano utilizzati ricambi originali.

Modello - Modèle - Model Modell - Modelo - Modelo	<b>PROFILE</b>	 epta refrigeration
Fabbricante - Constructeur - Manufacturer Hersteller - Fabricante - Fabricante	<b>Epta Spa</b> - Via Mecenate, 86 - 20138 Milano (MI) ITALIA Tel. 02/55403211 Telefax 02/55401023	<b>30/32</b>

EN

## 10.12 Smantellamento ed eliminazione

IT

In conformità alle norme per lo smantellamento dei rifiuti vigenti nei singoli Paesi e per il rispetto dell'ambiente in cui viviamo, vi preghiamo di dividere le parti del banco in modo da poterle smaltire separatamente o eventualmente recuperarle opportunamente.

FR

DE

ES

PT

Tutte le parti componenti il banco non sono assimilabili ai rifiuti solidi urbani fatta eccezione per le parti metalliche che comunque non figurano tra i rifiuti speciali per la maggior parte dei Paesi Europei.



Il sistema di refrigerazione è ad alta pressione. Contattare personale esperto prima della rottamazione.

I componenti del circuito di refrigerazione non devono essere tagliati e/o separati prima che venga scaricato il circuito, con recupero del gas refrigerante da parte di personale qualificato.

Modello - Modèle - Model Modell - Modelo - Modelo	<b>PROFILE</b>	 epta refrigeration
Fabbricante - Constructeur - Manufacturer Hersteller - Fabricante - Fabricante	<b>Epta Spa</b> - Via Mecenate, 86 - 20138 Milano (MI) ITALIA Tel. 02/55403211 Telefax 02/55401023	<b>31/32</b>

## 11. AVVERTENZE GENERALI INTEGRATIVE

### Istruzioni per la corretta installazione e manutenzione

Le istruzioni di uso e manutenzione si trovano nel Manuale Utente disponibile nel sito: [www.eptarefrigeration.com](http://www.eptarefrigeration.com).

Le istruzioni di installazione dedicate al personale esperto sono disponibili:

- Presso la rete di assistenza
- In alcune categorie di prodotto in forma cartacea consegnato insieme al prodotto

### Informazioni di prodotto

Le informazioni di prodotto (EPREL) sono disponibili collegandosi al sito <https://eprel.eptarefrigeration.com> e seguendo le istruzioni riportate per l'accesso al database.

### Garanzia

Il prodotto è coperto da garanzia, nei termini di legge, per un periodo di 12 mesi, salvo diversi accordi sottoscritti esplicitamente dalle parti.

### Servizi professionali di riparazione

I servizi sono erogati dalla nostra rete di assistenza consultabile nell'area contatti all'indirizzo web [www.eptarefrigeration.com](http://www.eptarefrigeration.com).

### Parti di ricambio

Le parti di ricambio e le informazioni per la riparazione dell'apparecchio sono disponibili per almeno 8 anni dopo che il prodotto viene dichiarato fuori produzione al seguente indirizzo web: [www.epta-service.com/service](http://www.epta-service.com/service).

Le credenziali di accesso sono fornite su richiesta da inviare via mail a: [servicesupport@eptarefrigeration.com](mailto:servicesupport@eptarefrigeration.com).

### Informazione importante sugli sprechi alimentari

Si raccomanda di seguire attentamente le istruzioni di conservazione riportate nelle confezioni dei prodotti e le indicazioni fornite dai produttori di alimenti.

Pertanto, le impostazioni di temperatura devono essere adeguate alle caratteristiche di conservazione dei prodotti alimentari coerentemente con le indicazioni riportate nella nostra documentazione tecnica.

Utilizzi non corretti possono causare un deperimento.

### Condizioni ambientali

Il presente apparecchio è destinato a funzionare in ambienti in cui la temperatura e l'umidità rientrano nei limiti previsti nel Manuale di uso e manutenzione.

### Istruzioni per il disassemblaggio

Per il disassemblaggio occorre rivolgersi ad operatori professionali.

Il gruppo Epta, da sempre animato da una particolare attenzione per l'ambiente, mette a disposizione degli utenti i manuali di smantellamento e trattamento dei rifiuti, scaricabili di seguito.

- Accedere al sito [www.bonnetneve.com](http://www.bonnetneve.com)



- Accedere alla sezione **area tecnica** del banco.

Modello - Modèle - Model Modell - Modelo - Modelo	<b>PROFILE</b>	
Fabbricante - Constructeur - Manufacturer Hersteller - Fabricante - Fabricante	<b>Epta Spa</b> - Via Mecenate, 86 - 20138 Milano (MI) ITALIA Tel. 02/55403211 Telefax 02/55401023	<b>32/32</b>

## User Manual

EN

IT

FR

DE

ES

PT

### Altre informazioni

Per ulteriori e più dettagliate informazioni si prega di fare riferimento a [www.eptarefrigeration.com](http://www.eptarefrigeration.com) ed a EPREL a cui si accede attraverso il QR code qui o nell'etichetta energetica del prodotto.



### Limiti di applicazione



Questo banco è progettato per l'utilizzo, il trasporto e l'immagazzinamento fino ad un'altitudine massima di 2000 m sul livello del mare.

#### Immagazzinamento:

- Temperatura compresa tra 15°C e 50°C
- Umidità relativa compresa tra 20% e 90%
- Tempo massimo 6 mesi

#### Trasporto:

- Temperatura compresa tra 20°C e 70°C
- Umidità relativa compresa tra 20% e 90%
- Tempo massimo 2 mesi

### Utilizzo:

La classe climatica di utilizzo è riportata sulla targa matricolare.

Di seguito è riportato un estratto della Norma di riferimento, che chiarisce il significato dei caratteri alfanumerici:

Classe climatica	Temperatura bulbo secco	Umidità relativa
[-]	[°C]	[%]
0	20	50
1	16	80
8	24	55
2	22	65
3	25	60
4	30	55
6	27	70
5	40	40
7	35	75

ESEMPIO Classe climatica 3 significa 25°C / 60%R.H.

### Prestazioni



Le condizioni ambientali esterne necessarie per un corretto funzionamento del banco sono specificate sulla targa matricolare.

Le prestazioni del banco non sono garantite al di fuori del suo normale utilizzo.



La temperatura minima non deve essere minore di 16°C.

Modello - Modèle - Model Modell - Modelo - Modelo	<b>PROFILE</b>	 epta refrigeration
Fabbricante - Constructeur - Manufacturer Hersteller - Fabricante - Fabricante	<b>Epta Spa</b> - Via Mecenate, 86 - 20138 Milano (MI) ITALIA Tel. 02/55403211 Telefax 02/55401023	<b>4/32</b>

- EN
- IT
- FR**
- DE
- ES
- PT

## SYMBOLIQUE UTILISÉE



Symbole d'interdiction: interdiction d'effectuer certaines opérations.



Symbole d'attention: normes anti-accident pour l'opérateur.



Symbole d'avertissement: risque d'endommager le meuble réfrigéré et/ou ses composants.



Symbole de remarque: fourniture d'informations utiles.

Modello - Modèle - Model Modell - Modelo - Modelo	<b>PROFILE</b>	 epta refrigeration
Fabbricante - Constructeur - Manufacturer Hersteller - Fabricante - Fabricante	<b>Epta Spa</b> - Via Mecenate, 86 - 20138 Milano (MI) ITALIA Tel. 02/55403211 Telefax 02/55401023	<b>5/32</b>

**TABLE DES MATIÈRES**

<b>1. Introduction</b>	<b>6</b>	<b>EN</b>
<b>2. Avertissements de sécurité</b>	<b>7</b>	<b>IT</b>
2.1 Avertissements généraux	7	
2.2 Avertissements pour l'entretien du meuble réfrigéré	9	<b>FR</b>
2.3 Avertissements électriques	9	
2.4 Interdictions	10	
<b>3. Description générale</b>	<b>11</b>	<b>DE</b>
3.1 Vues en coupe	13	
<b>4. Transport du meuble réfrigéré</b>	<b>19</b>	<b>ES</b>
<b>5. Conditions ambiantes</b>	<b>20</b>	<b>PT</b>
6.1 Référence des modèles / désignation	21	
<b>6. Caractéristiques techniques</b>	<b>21</b>	
<b>7. Utilisation du meuble réfrigéré</b>	<b>22</b>	
<b>8. Entretien ordinaire</b>	<b>24</b>	
8.1 Nettoyage du meuble réfrigéré	24	
<b>9. Définition configuration étagères</b>	<b>25</b>	
<b>10. Indications utilisateur</b>	<b>26</b>	
10.1 Descriptions du meuble réfrigéré	26	
10.2 Transport et déplacement	26	
10.3 Réception et stockage	26	
10.4 Installation et conditions ambiantes	27	
10.5 Connexion électrique	27	
10.6 Caractéristiques techniques	27	
10.7 Chargement du produit	27	
10.8 Utilisation du meuble réfrigéré	28	
10.9 Nettoyage et entretien ordinaire	28	
10.10 Situations d'urgence	29	
10.11 Service après-vente	29	
10.12 Démantèlement et élimination	30	
<b>11. Avertissements généraux supplémentaires</b>	<b>31</b>	

Modello - Modèlo - Model Modell - Modelo - Modelo	<b>PROFILE</b>	
Fabbricante - Constructeur - Manufacturer Hersteller - Fabricante - Fabricante	<b>Epta Spa</b> - Via Mecenate, 86 - 20138 Milano (MI) ITALIA Tel. 02/55403211 Telefax 02/55401023	<b>6/32</b>

## 1. INTRODUCTION

Veillez lire attentivement ce manuel et le conserver avec le meuble réfrigéré.

Le constructeur décline toute responsabilité pour tout préjudice causé aux personnes ou aux biens, dû au non-respect des consignes indiquées dans ce manuel.

Le présent manuel d'utilisation s'applique à une famille de produits disponible en différentes configurations et dimensions ; les performances et les spécifications de chaque modèle sont complétées par les informations figurant sur la plaque signalétique, la Déclaration CE de conformité, ainsi que par l'étiquette énergétique et la fiche d'information produit EPREL correspondante.

Les performances de chaque modèle individuel peuvent varier en fonction de la configuration spécifique. L'étiquette énergétique et la fiche d'information produit sont également disponibles sur <https://eprel.eptarefrigeration.com> en saisissant le numéro de série figurant sur la plaque signalétique.



Ce manuel fournit les informations considérées comme nécessaires pour une utilisation correcte et un bon fonctionnement du meuble réfrigéré.

Il contient les descriptions et les informations suivantes:

- une description fonctionnelle du meuble réfrigéré et de chacune de ses parties
- des informations concernant la sécurité du meuble réfrigéré et les règles anti-accident auxquelles se conformer
- une utilisation correcte du meuble réfrigéré
- un bon entretien ordinaire et programmé, y compris les opérations de nettoyage

Informations non contenues dans ce manuel:

- Instructions d'installation

Pour une installation correcte du meuble réfrigéré, veuillez faire référence aux documents suivants:

- Manuel technique
- Instructions de référence rapides

Ce manuel s'adresse aux professionnels suivants:

- **OPÉRATEUR QUALIFIÉ** personne qualifiée, instruite pour effectuer le fonctionnement, le réglage, le nettoyage et l'entretien ordinaire du meuble réfrigéré
- **TECHNICIEN SPÉCIALISÉ** formé et autorisé par l'organisme indiqué dans le contrat (constructeur/concessionnaire/distributeur) à effectuer: l'installation, l'entretien exceptionnel, la réparation, le remplacement et la révision du meuble réfrigéré

Ces instructions sont aussi disponibles sur : [www.eptarefrigeration.com](http://www.eptarefrigeration.com).

**En ce qui concerne les réglementations et les certifications du meuble réfrigéré, veuillez faire référence à la déclaration de conformité.**

**Conservez toujours le livret d'instructions, y compris en cas de vente.**

Modello - Modèle - Model Modell - Modelo - Modelo	<b>PROFILE</b>	 eptarefrigeration
Fabbricante - Constructeur - Manufacturer Hersteller - Fabricante - Fabricante	<b>Epta Spa</b> - Via Mecenate, 86 - 20138 Milano (MI) ITALIA Tel. 02/55403211 Telefax 02/55401023	<b>7/32</b>

## 2. AVERTISSEMENTS DE SÉCURITÉ

### 2.1 Avertissements généraux



La désignation de l'appareil est indiquée à la page "21".



Cet appareil est conçu pour fonctionner en classe ambiante 3 ou 4 ; la définition de la classe ambiante est fournie à la page "32".



Le constructeur décline toute responsabilité pour tout préjudice corporel ou matériel dû à un manque d'observation des avertissements contenus dans ce manuel. Toute personne utilisant ce meuble réfrigéré doit impérativement avoir lu le manuel de l'utilisateur.



Toutes les opérations de déplacement, transport, assemblage et démontage, durant la mise hors service, et lors de la mise au rebut, doivent être réalisées exclusivement par du personnel qualifié.



L'employeur doit instruire ses personnels sur les risques d'accident, les dispositifs prévus pour la sécurité des personnels, les risques d'émissions sonores et les règles générales de prévention des accidents requises par la réglementation en vigueur.



L'utilisation technique du meuble est réservée aux personnes autorisées et formées; les activités d'utilisation technique comprennent, par exemple, la mise en marche, les réglages, le nettoyage et l'entretien.



L'utilisation du meuble à des fins non techniques, telles que l'ouverture des portes pour retirer les produits exposés, peut également être effectuée par des enfants âgés de 8 ans ou plus, ou par des personnes ayant des capacités physiques, sensorielles ou mentales réduites, ou manquant d'expérience et de connaissances, à condition qu'elles aient été dûment surveillées ou instruites concernant l'utilisation de l'appareil en toute sécurité et qu'elles aient compris les dangers encourus.

Les enfants doivent être surveillés afin de s'assurer qu'ils ne jouent pas avec l'appareil.

Le nettoyage et l'entretien ne doivent pas être effectués par des enfants sans surveillance.



Tout autre usage non explicitement indiqué dans ce manuel doit être considéré comme dangereux, et le constructeur ne pourra être tenu pour responsable d'éventuels dommages dérivant d'une utilisation impropre, erronée et non raisonnable.



Le meuble réfrigéré doit être utilisé par des personnels munis des équipements de protection individuelle appropriés.



Instruire toute personne utilisant le meuble sur la position de l'interrupteur-sectionneur.



Le port de gants de travail est obligatoire.



Le retrait de protections ou de panneaux requérant l'utilisation d'outils doit exclusivement être effectué par des personnels qualifiés.

EN

IT

FR

DE

ES

PT

Modello - Modèle - Model Modell - Modelo - Modelo	<b>PROFILE</b>	 epta refrigeration
Fabbricante - Constructeur - Manufacturer Hersteller - Fabricante - Fabricante	<b>Epta Spa</b> - Via Mecenate, 86 - 20138 Milano (MI) ITALIA Tel. 02/55403211 Telefax 02/55401023	<b>8/32</b>

## User Manual

EN

 Toute intervention doit exclusivement être effectuée par des personnels qualifiés. Dans tous les cas, avant toute intervention, couper impérativement l'alimentation électrique du meuble.

IT

FR

DE

ES

PT

 Le réglage du thermostat est réservé au personnel technique du service après-vente.

 Pour le montage d'accessoires dédiés, en option, veuillez vous adresser au service après-vente agréé le plus proche.

 Ne pas laisser le meuble réfrigéré exposé aux agents atmosphériques.

 Ne pas utiliser des jets d'eau directs ou indirects sur le meuble réfrigéré.

 Ne pas toucher le meuble réfrigéré avec les mains ou les pieds mouillés ou humides, ne pas utiliser le meuble réfrigéré les pieds nus.

 Faire attention aux parties chaudes ou en mouvement marquées du symbole approprié.

 Ne pas endommager le circuit réfrigérant.

 Éviter les flammes ou les étincelles à l'intérieur de l'appareil.

 En cas d'incendie, ne pas utiliser de l'eau pour éteindre les flammes, mais exclusivement des extincteurs à sec.

 Ne pas utiliser d'appareils électriques à l'intérieur des compartiments de l'appareil destinés à la conservation des aliments frais ou congelés, sauf s'ils sont du type recommandé par le fabricant.

 Ne pas conserver de substances explosives ou dangereuses, telles que des récipients sous pression contenant du gaz propulseur inflammable, à l'intérieur de cet appareil.

 Ne placez pas de contenants de liquide et ne versez pas de liquide sur le comptoir.

 Veillez à ce que les fentes d'aération du caisson de l'appareil soient toujours bien dégagées.

 Les informations relatives à la charge maximale admissible pour chaque type d'étagère sont fournies à la page "27".

 Ne pas poser de poids sur le toit du meuble réfrigéré; il est opportun d'éviter de placer des aliments non emballés directement sur les plateaux, veuillez utiliser des conteneurs pour aliments appropriés.

Modello - Modèle - Model Modell - Modelo - Modelo	<b>PROFILE</b>	 eptarefrigeration
Fabbricante - Constructeur - Manufacturer Hersteller - Fabricante - Fabricante	<b>Epta Spa</b> - Via Mecenate, 86 - 20138 Milano (MI) ITALIA Tel. 02/55403211 Telefax 02/55401023	<b>9/32</b>

## 2.2 Avertissements pour l'entretien du meuble réfrigéré

 Les opérations d'entretien sont exclusivement réservées aux personnels autorisés.

 L'accès aux parties électriques et/ou aux parties nécessitant l'utilisation d'outils est réservé aux techniciens spécialisés.

 Avant toute opération d'entretien ou de nettoyage réservée à l'utilisateur, couper la tension au meuble en intervenant sur l'interrupteur-sectionneur général mural.

 Faire attention aux parties chaudes ou en mouvement marquées du symbole approprié.

 Le port de gants de travail est obligatoire.

 Il est important de respecter le type et la fréquence des inspections et des opérations de maintenance requises pour un fonctionnement sûr, y compris les mesures de maintenance préventive, telles que décrites dans le paragraphe "Nettoyage et entretien ordinaire" sur la page "28".

## 2.3 Avertissements électriques

 S'assurer que la tension d'alimentation correspond aux caractéristiques de la plaque du meuble.

 L'installation électrique doit être effectuée dans les règles de l'art par des techniciens spécialisés.

 Le retrait du couvercle du tableau électrique est réservé aux techniciens spécialisés.

 Conformément aux règles d'installation, le réseau d'alimentation doit comporter un dispositif de déconnexion omnipolaire, assurant la déconnexion complète du secteur dans les conditions de surtension de catégorie III.

 L'installation du meuble réfrigéré doit être effectuée conformément aux instructions du constructeur, par des personnels professionnellement qualifiés et dans le respect des normes sur les installations électriques en vigueur dans chaque pays.

 Toute installation erronée du meuble réfrigéré risque de causer des préjudices aux personnes, aux animaux ou aux biens par rapport auxquels le constructeur décline toute responsabilité.

 Si le cordon d'alimentation est endommagé, il doit être remplacé par du personnel de service autorisé pour éviter un danger. N'essayez pas de réparer le câble.

 Ne pas alimenter le meuble s'il est endommagé. En cas de doute, contactez le service après-vente ou votre revendeur.

EN

IT

FR

DE

ES

PT

Modello - Modèle - Model Modell - Modelo - Modelo	<b>PROFILE</b>	 epta refrigeration
Fabbricante - Constructeur - Manufacturer Hersteller - Fabricante - Fabricante	<b>Epta Spa</b> - Via Mecenate, 86 - 20138 Milano (MI) ITALIA Tel. 02/55403211 Telefax 02/55401023	<b>10/32</b>

## 2.4 Interdictions

EN

IT

FR

DE

ES

PT

 Il est interdit d'utiliser des dispositifs autres que ceux fournis par le constructeur dans le meuble réfrigéré, pour accélérer le dégivrage.

 Il est interdit aux personnels non spécialisés de retirer le couvercle du tableau électrique ou d'ouvrir des panneaux nécessitant l'utilisation d'outils.

 Il est interdit d'utiliser le meuble réfrigéré pour conserver et/ou exposer des substances explosives, inflammables ou corrosives, telles par exemple des bombes aérosol contenant un gaz propulseur inflammable.

 Il est interdit d'utiliser le meuble réfrigéré pour conserver et/ou exposer des produits pharmaceutiques.

 Il est interdit d'installer le meuble réfrigéré dans un environnement contenant des substances gazeuses explosives.

 Il est interdit de retirer la plaque du matricule du meuble réfrigéré.

 Il est interdit de monter sur le comptoir ou sur le pare-chocs du comptoir.

 Il est interdit de remplacer des composants et/ou de modifier le meuble réfrigéré hors des spécifications prévues par le constructeur, ainsi que de remplacer des pièces de rechange d'origine par d'autres non homologuées par le constructeur, sous peine d'invalider la garantie.

Modello - Modèle - Model Modell - Modelo - Modelo	<b>PROFILE</b>	 epta refrigeration
Fabbricante - Constructeur - Manufacturer Hersteller - Fabricante - Fabricante	<b>Epta Spa</b> - Via Mecenate, 86 - 20138 Milano (MI) ITALIA Tel. 02/55403211 Telefax 02/55401023	<b>11/32</b>

### 3. DESCRIPTION GÉNÉRALE

Ouvert



1. Plaque des caractéristiques
2. Éclairage supérieur
3. Rideaux de nuit
4. Etagères
5. Vitres latérales
6. Interrupteur lumière
7. Téléthermostat

Fermé (Portes en verre)



1. Plaque des caractéristiques
2. Éclairage supérieur
3. Portes en verre
4. Etagères
5. Vitres latérales
6. Interrupteur lumière
7. Téléthermostat

EN

IT

FR

DE

ES

PT

Modello - Modèle - Model Modell - Modelo - Modelo	<b>PROFILE</b>	 epta refrigeration
Fabbricante - Constructeur - Manufacturer Hersteller - Fabricante - Fabricante	<b>Epta Spa</b> - Via Mecenate, 86 - 20138 Milano (MI) ITALIA Tel. 02/55403211 Telefax 02/55401023	<b>12/32</b>

## User Manual

### EN Fermé (Portes coulissantes en verre)

EN

IT

FR

DE

ES

PT



1. *Plaque des caractéristiques*
2. *Éclairage supérieur*
3. *Portes coulissantes en verre*
4. *Etagères*
5. *Vitres latérales*
6. *Interrupteur lumière*
7. *Téléthermostat*

Modello - Modèle - Model Modell - Modelo - Modelo	<b>PROFILE</b>	 epta refrigeration
Fabbricante - Constructeur - Manufacturer Hersteller - Fabricante - Fabricante	<b>Epta Spa</b> - Via Mecenate, 86 - 20138 Milano (MI) ITALIA Tel. 02/55403211 Telefax 02/55401023	<b>13/32</b>

### 3.1 Vues en coupe

#### H20Ouvert

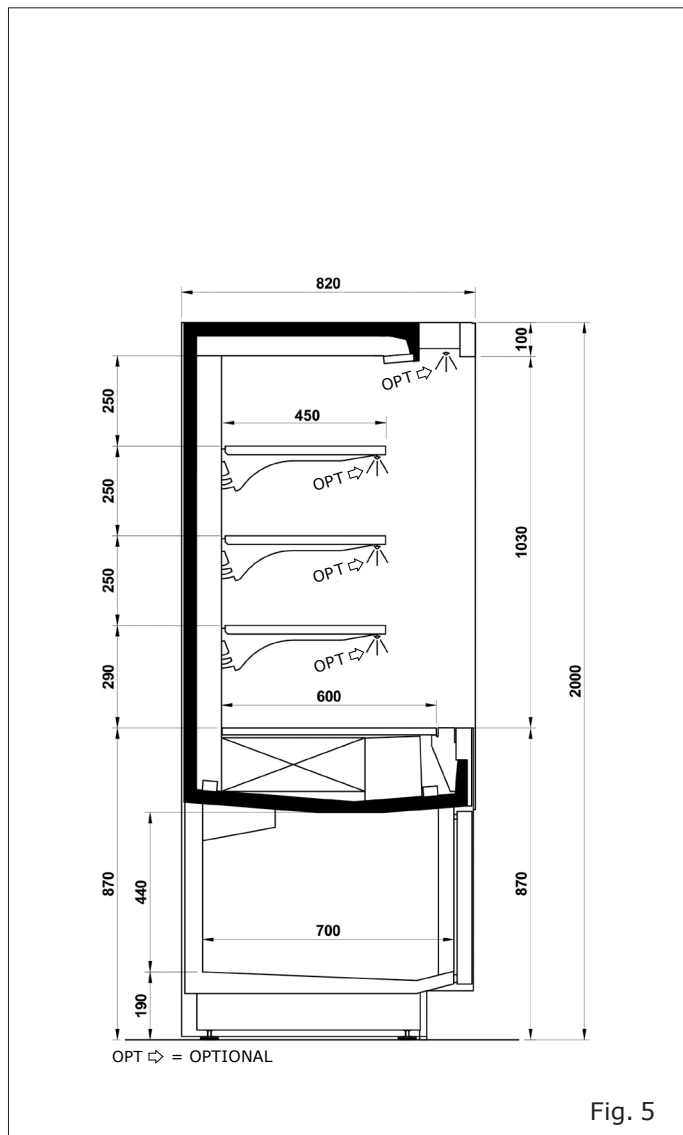

#### H20Ouvert avec crochets

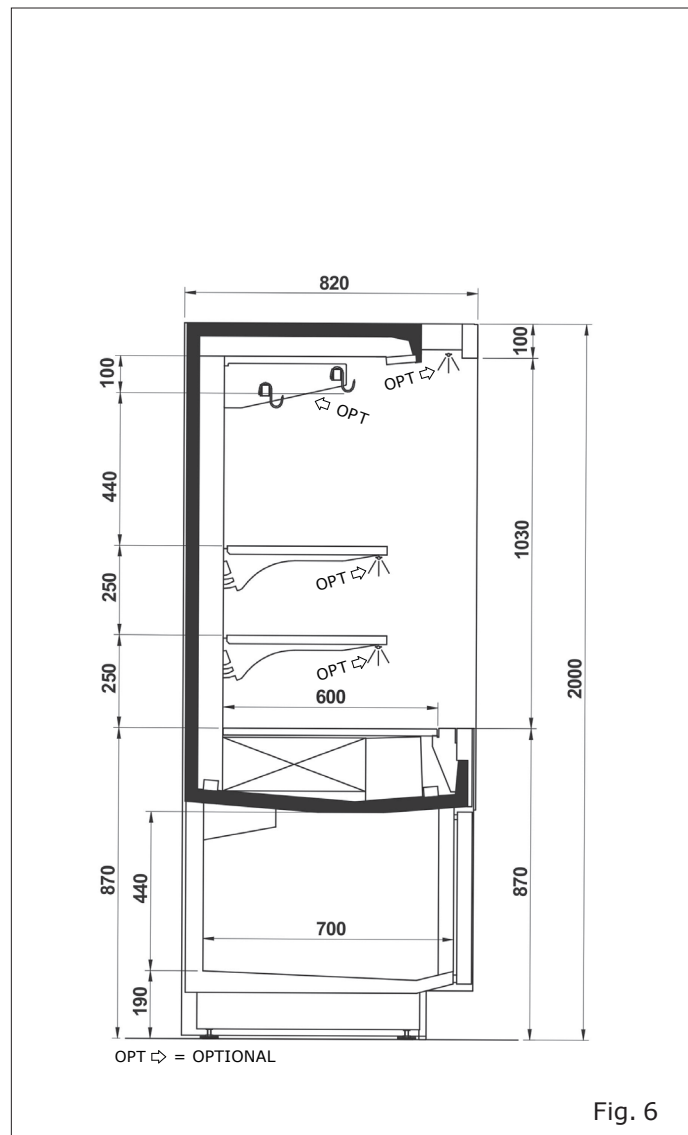

- EN
- IT
- FR**
- DE
- ES
- PT



Modello - Modèle - Model Modell - Modelo - Modelo	<h1>PROFILE</h1>	
Fabbricante - Constructeur - Manufacturer Hersteller - Fabricante - Fabricante	<b>Epta Spa</b> - Via Mecenate, 86 - 20138 Milano (MI) ITALIA Tel. 02/55403211 Telefax 02/55401023	<b>15/32</b>

## H20Fermé (Portes coulissantes en verre)

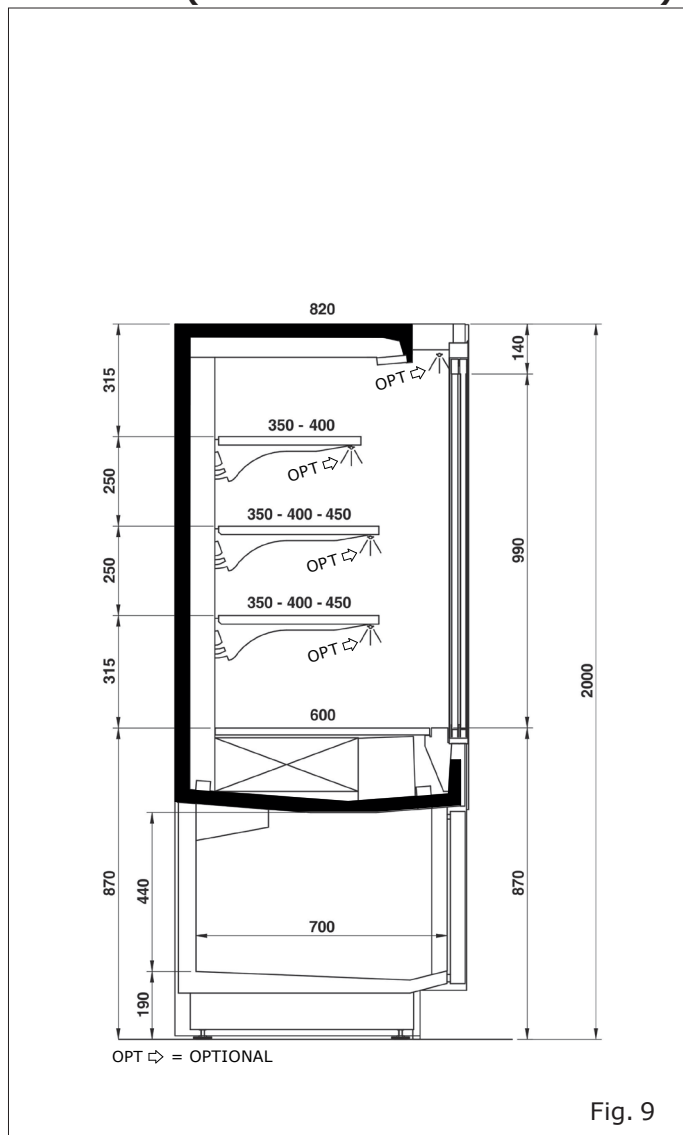

## H22Ouvert

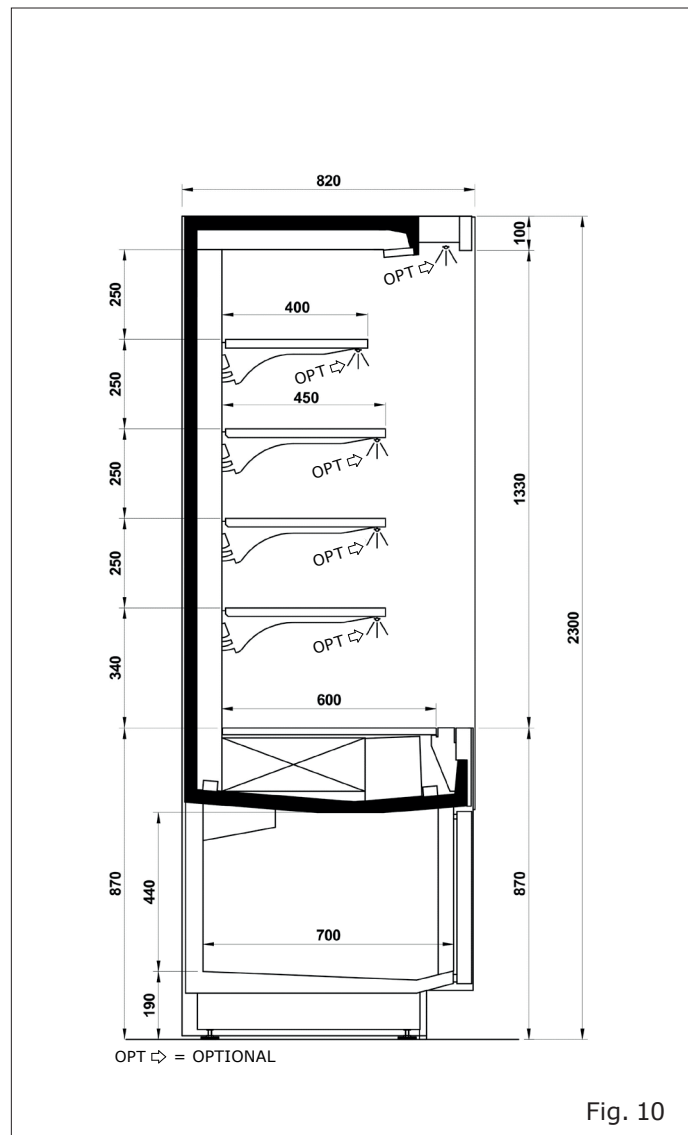

EN

IT

FR

DE

ES

PT



Modello - Modèle - Model Modell - Modelo - Modelo	<b>PROFILE</b>	
Fabbricante - Constructeur - Manufacturer Hersteller - Fabricante - Fabricante	<b>Epta Spa</b> - Via Mecenate, 86 - 20138 Milano (MI) ITALIA Tel. 02/55403211 Telefax 02/55401023	<b>17/32</b>

### H22Fermé avec crochets (Portes en verre)

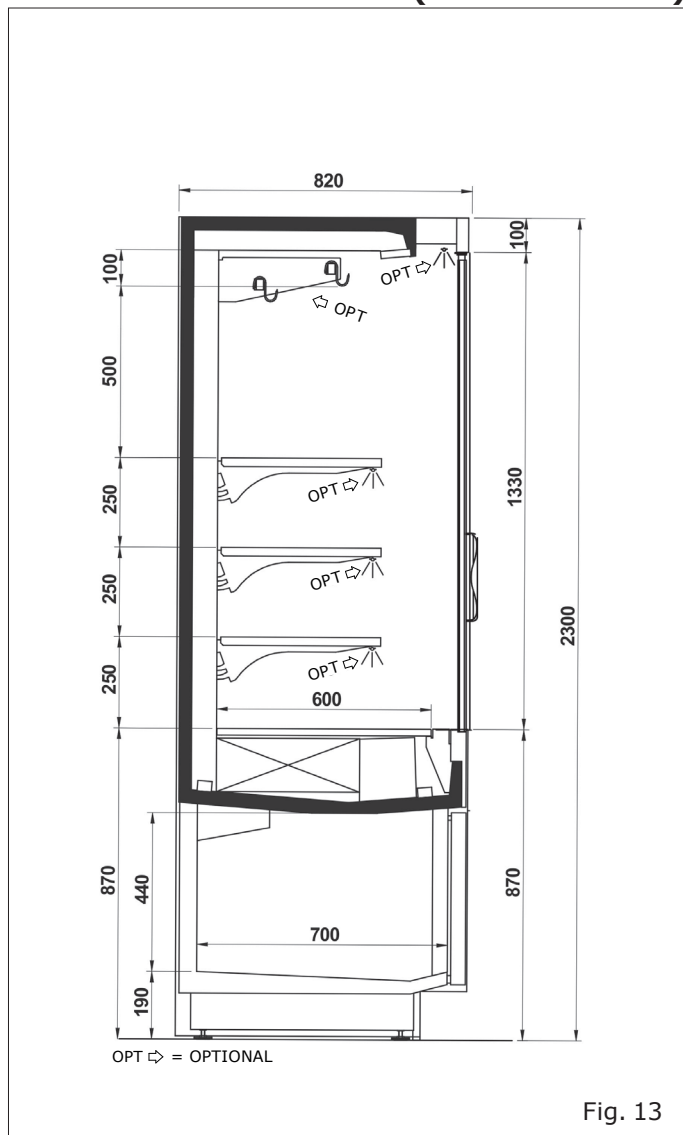

### H22Fermé (Portes coulissantes en verre)

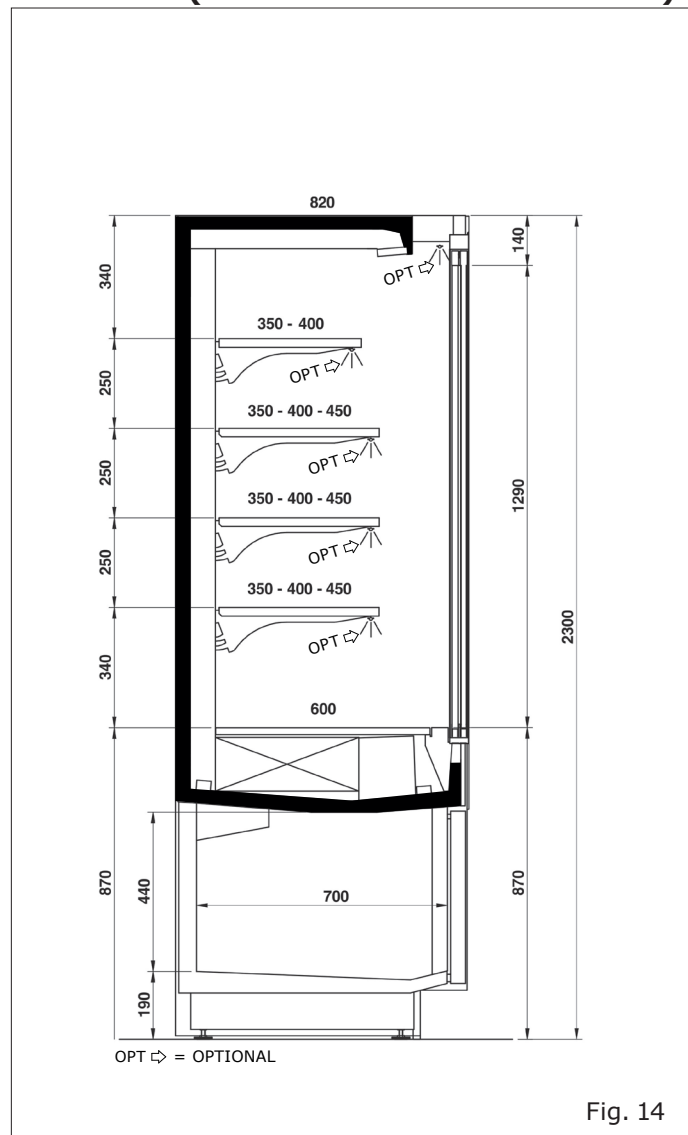

- EN
- IT
- FR**
- DE
- ES
- PT

Modello - Modèle - Model Modell - Modelo - Modelo	<h1>PROFILE</h1>	 eptarefrigeration
Fabbricante - Constructeur - Manufacturer Hersteller - Fabricante - Fabricante	<b>Epta Spa</b> - Via Mecenate, 86 - 20138 Milano (MI) ITALIA Tel. 02/55403211 Telefax 02/55401023	<b>18/32</b>

User Manual

- EN
- IT
- FR
- DE
- ES
- PT

## H26Ouvert

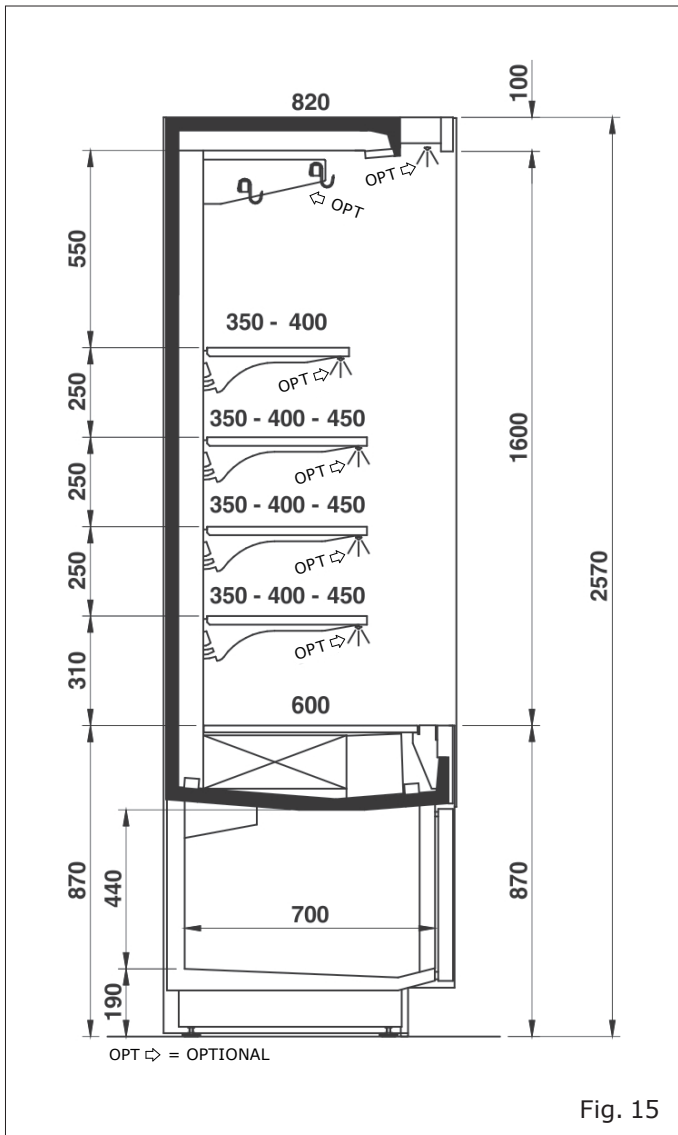

Modello - Modèle - Model Modell - Modelo - Modelo	<b>PROFILE</b>	 eptarefrigeration
Fabbricante - Constructeur - Manufacturer Hersteller - Fabricante - Fabricante	<b>Epta Spa</b> - Via Mecenate, 86 - 20138 Milano (MI) ITALIA Tel. 02/55403211 Telefax 02/55401023	<b>19/32</b>

## 4. TRANSPORT DU MEUBLE RÉFRIGÉRÉ



### 1. Points de levage

**Tab. I**

Hauteur	Longueur	Poids (kg)	Poids avec emballage (kg)
2000	1250	85	95
	1875	215	240
	2500	365	400
2300	1250	100	120
	1875	250	280
	2500	400	440
2500	1250	115	135
	1875	285	315
	2500	435	475

Modello - Modèle - Model Modell - Modelo - Modelo	<b>PROFILE</b>	
Fabbricante - Constructeur - Manufacturer Hersteller - Fabricante - Fabricante	<b>Epta Spa</b> - Via Mecenate, 86 - 20138 Milano (MI) ITALIA Tel. 02/55403211 Telefax 02/55401023	<b>20/32</b>

EN  
IT  
FR  
DE  
ES  
PT

## 5. CONDITIONS AMBIANTES



**Tab. II**

Caractéristiques	
Type de local	Fermé
Température	25°C
Humidité relative	60 %
Éclairage	600 lx



Modello - Modèle - Model Modell - Modelo - Modelo	<b>PROFILE</b>	 epta refrigeration
Fabbricante - Constructeur - Manufacturer Hersteller - Fabricante - Fabricante	<b>Epta Spa</b> - Via Mecenate, 86 - 20138 Milano (MI) ITALIA Tel. 02/55403211 Telefax 02/55401023	<b>21/32</b>

## 6. CARACTÉRISTIQUES TECHNIQUES









 <small>EPTA S.p.A. Via Mecenate, 86 20138 Milano - Italy</small>		 12	
1                      2		SN 13	 14
3                      4		REF 15	16
RATED BEMESSUNG ASSIGNÉ NOMINALE NOMINAL	5                      6	REFRIGERANT KÄLTEMITTEL RÉFRIGÉRANT REFRIGERANTE REFRIGERANTE	17                      18 19                      20
DEFROSTING ABTAUUNG DÉGIVRAGE SBRINAMENTO DESCONGELAMIENTO	7                      8	CLIMATIC CLASS KLIMAKLASSE CLASSE CLIMATICA CLASSE CLIMATICA CLASE CLIMÁTICA	
HEATING SYSTEMS HEIZUNGSSYSTEME SYSTEMES CHAUFFANTS SISTEMI DI RISCALDAMENTO SISTEMA DE CALEFACCIÓN	9	INSULATION BLOWING GAS ISOLATIONS GAS (BLÄHGAS) AGENT MOUSSANT D'ISOLATION GAS ESPANDENTE ISOLAMENTO AGENTE ESPUMANTE	
	10	PROTECTION INDEX SCHÜTZART INDEX DE LA PROTECTION INDICE DI PROTEZIONE ÍNDICE DE PROTECCIÓN	
	 11	24	  
<small>Read Operator's Manual available at <a href="http://www.eptarefrigeration.com">www.eptarefrigeration.com</a> or calling: +39 0437 968379</small>			

Fig. 20

- |   |  |
|---|--|
| <ol style="list-style-type: none"> <li>1. Origine du produit</li> <li>2. Produit dans le "Pays d'origine"</li> <li>3. Tension nominale</li> <li>4. Puissance nominale</li> <li>5. Fréquence nominale</li> <li>6. Courant nominal</li> <li>7. Puissance de dégivrage</li> <li>8. Courant de dégivrage</li> <li>9. Système de chauffe</li> <li>10. Système d'éclairage</li> <li>11. Manuel de l'opérateur</li> <li>12. Code-barres</li> </ol> | <ol style="list-style-type: none"> <li>13. Numéro de série</li> <li>14. Date de fabrication</li> <li>15. Code Hat</li> <li>16. Modèle/désignation</li> <li>17. Type de réfrigérant 1</li> <li>18. Masse de réfrigérant 1</li> <li>19. Type de réfrigérant 2</li> <li>20. Masse de réfrigérant 2</li> <li>21. Classe climatique</li> <li>22. Isolation gaz</li> <li>23. Indice de protection</li> <li>24. Marques de certification</li> </ol> |
|---|--|

### 6.1 Référence des modèles / désignation

Le tableau explique comment lire le code modèle, en indiquant les informations commerciales pertinentes pour chaque partie de la référence (voir champ de l'étiquette numéro : "16").

#### PROFILE xxx (Meuble frigorifique)

Référence / désignation	Description	Informations commerciales
Profile	Nom	Profile
xxx	Longueur	125(1250), 188(1875), 250(2500)

exemple:  
Profile125 = Profile 1250

Modello - Modèle - Model Modell - Modelo - Modelo	<b>PROFILE</b>	 epta refrigeration
Fabbricante - Constructeur - Manufacturer Hersteller - Fabricante - Fabricante	<b>Epta Spa</b> - Via Mecenate, 86 - 20138 Milano (MI) ITALIA Tel. 02/55403211 Telefax 02/55401023	<b>22/32</b>

EN  
IT  
FR  
DE  
ES  
PT

## 7. UTILISATION DU MEUBLE RÉFRIGÉRÉ



Ne pas couvrir

Uniquement pour le modèle ouvert

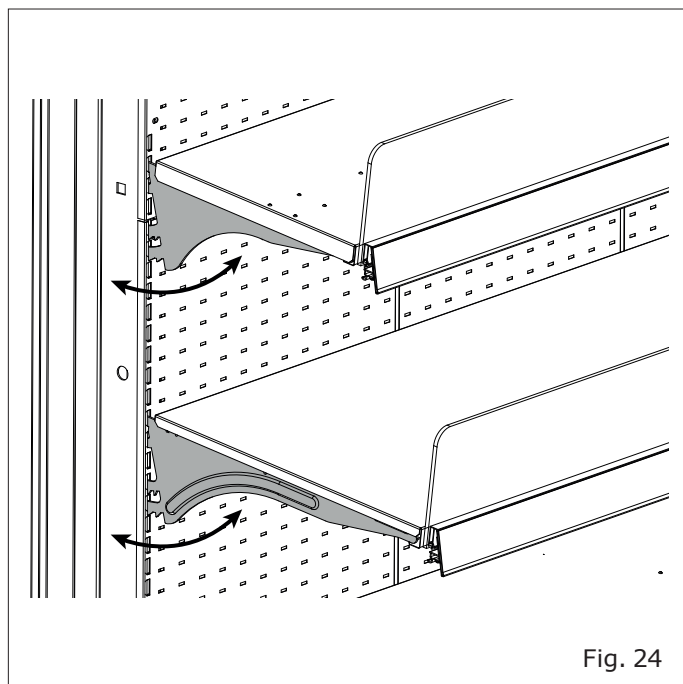

Inclinaison étagères: 0° - 7° - 14° - 21°

Modello - Modèle - Model Modell - Modelo - Modelo	<h1>PROFILE</h1>	
Fabbricante - Constructeur - Manufacturer Hersteller - Fabricante - Fabricante	<b>Epta Spa</b> - Via Mecenate, 86 - 20138 Milano (MI) ITALIA Tel. 02/55403211 Telefax 02/55401023	<b>23/32</b>



- EN
- IT
- FR**
- DE
- ES
- PT

Modello - Modèle - Model Modell - Modelo - Modelo	<b>PROFILE</b>	
Fabbricante - Constructeur - Manufacturer Hersteller - Fabricante - Fabricante	<b>Epta Spa</b> - Via Mecenate, 86 - 20138 Milano (MI) ITALIA Tel. 02/55403211 Telefax 02/55401023	<b>24/32</b>

- EN
- IT
- FR
- DE
- ES
- PT

## 8. ENTRETIEN ORDINAIRE

### 8.1 Nettoyage du meuble réfrigéré

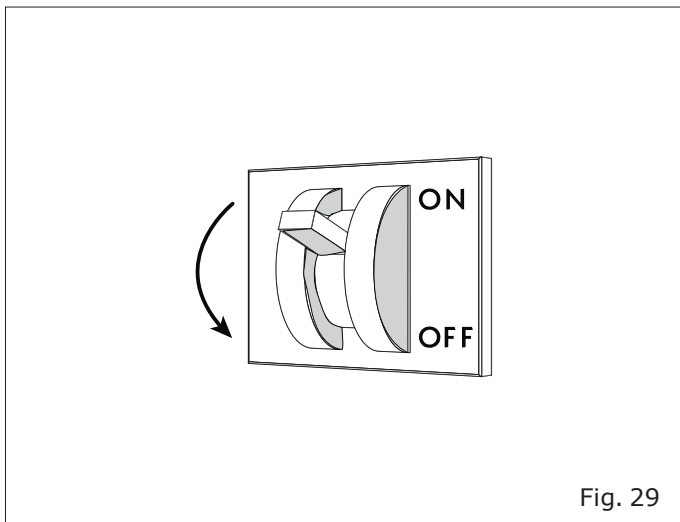

Modello - Modèle - Model Modell - Modelo - Modelo	<b>PROFILE</b>	 epta refrigeration
Fabbricante - Constructeur - Manufacturer Hersteller - Fabricante - Fabricante	<b>Epta Spa</b> - Via Mecenate, 86 - 20138 Milano (MI) ITALIA Tel. 02/55403211 Telefax 02/55401023	<b>25/32</b>

## 9. DÉFINITION CONFIGURATION ÉTAGÈRES

Tab. III

Configuration d'étagère à profondeur unique			
Niveau	Avec crochets	Sans crochets	H20
1	x	x	350-400-450 350-400-450
2	x	x	350-400-450 350-400-451
3	x	-	350-400-450 350-400-452

Configuration d'étagère à profondeur unique			
Niveau	Avec crochets	Sans crochets	H23
1	x	x	350-400-450 350-400-450
2	x	x	350-400-450 350-400-451
3	x	x	350-400-450 350-400-452
4	x	-	350-400-450 350-400-453

Modello - Modèle - Model Modell - Modelo - Modelo	<b>PROFILE</b>	 eptarefrigeration
Fabbricante - Constructeur - Manufacturer Hersteller - Fabricante - Fabricante	<b>Epta Spa</b> - Via Mecenate, 86 - 20138 Milano (MI) ITALIA Tel. 02/55403211 Telefax 02/55401023	<b>26/32</b>

## 10. INDICATIONS UTILISATEUR

### 10.1 Descriptions du meuble réfrigéré

Le meuble a été conçu et fabriqué exclusivement pour l'exposition de denrées alimentaires fraîches préemballées, boissons et produits laitiers.

CLASSE DE TEMPÉRATURE (suivant EN ISO 23953-2):

- Ouvert H20/H23: 3M1/3M2, H26: 3M2
- Fermé H20/H23/H26: 3M1

Les caractéristiques générales et les dimensions sont illustrées dans les figures et les vues en coupe indiquées au chapitre "Description générale" (de la page "11" à la page "18").

Les réglages de température recommandés pour chaque compartiment, afin d'assurer une conservation optimale des aliments, sont indiqués dans la fiche d'information produit disponible dans EPREL ou en accédant au site <https://eprel.eptarefrigeration.com> et en suivant les instructions fournies pour l'accès à la base de données.

Durant le transport, le déplacement, la réception, le stockage, l'installation, le chargement, l'utilisation, le nettoyage, l'entretien et le démantèlement, prêter particulièrement attention au risque de basculement du meuble ("Fig. 31").

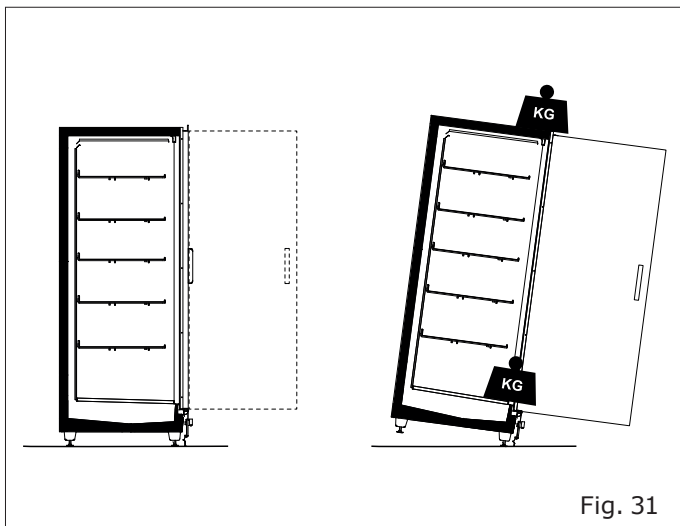

Fig. 31

### 10.2 Transport et déplacement

Le meuble réfrigéré est contenu dans un emballage spécial muni d'une plateforme pour le déplacement avec des chariots à fourche.

Pour le transport et le déplacement du meuble réfrigéré, utiliser:

- exclusivement une plateforme prévue à cet effet ou équivalente
- Un chariot élévateur manuel ou électrique adapté au soulèvement du meuble, présentant des caractéristiques appropriées dans le respect des normes en vigueur

Le poids du meuble réfrigéré (vide et avec emballage) et les dimensions de l'emballage sont indiqués au chapitre "Transport du meuble réfrigéré" (tableau "Tab. I" et figures à la page "19").

Les opérations de déplacement doivent être effectuées par des personnels qualifiés, en mesure d'évaluer les poids, les points de levage et les moyens les plus adaptés, tant en ce qui concerne la sécurité que la portée.

### 10.3 Réception et stockage

Vérifier l'état de l'emballage avant de prendre livraison du meuble réfrigéré du transporteur.

En cas de dommages évidents à l'emballage:

- Retirer l'emballage du meuble réfrigéré en présence du transporteur.
- Signer sous réserve le bon de livraison.

Le constructeur ne répond pas des dommages éventuellement dus au transport ou à un stockage erroné du meuble réfrigéré.

Conserver le meuble dans un endroit à l'abri du soleil et des intempéries, à une température comprise entre -25°C et +55°C et avec une humidité relative de l'air comprise entre 30% et 95%.

Modello - Modèle - Model Modell - Modelo - Modelo	<b>PROFILE</b>	 eptarefrigeration
Fabbricante - Constructeur - Manufacturer Hersteller - Fabricante - Fabricante	<b>Epta Spa</b> - Via Mecenate, 86 - 20138 Milano (MI) ITALIA Tel. 02/55403211 Telefax 02/55401023	<b>27/32</b>

## 10.4 Installation et conditions ambiantes

Ce meuble réfrigéré n'est pas conçu pour être installé à l'extérieur.

Pour que le meuble fonctionne correctement, vérifier qu'il est mis en place:

- Sur un sol nivelé ("Fig. 18").
- Loin de toute source de chaleur, rayons directs du soleil, portes, fenêtres, ventilateurs et bouches d'aération ("Fig. 19").

Assurer l'espace nécessaire à l'utilisation du meuble réfrigéré par la clientèle.

Les conditions du lieu où installer le meuble sont indiquées dans: "Conditions ambiantes" (tableau "Tab. II", Page"20").

## 10.5 Connexion électrique

Installer un interrupteur-sectionneur omnipolaire en amont du meuble réfrigéré. L'interrupteur-sectionneur doit avoir pouvoir d'interruption adapté.

L'interrupteur-sectionneur doit être situé en amont du meuble et doit être visible par l'opérateur lors des opérations de nettoyage et d'entretien, ou être muni d'un disjoncteur avec système de blocage en position isolée.

Avant de brancher le meuble réfrigéré, s'assurer que la tension d'alimentation correspond aux caractéristiques de la plaque du meuble. Pour garantir un fonctionnement régulier, la variation de tension maximale doit être comprise entre +/- 6% de la valeur nominale.

## 10.6 Caractéristiques techniques

La plaque matricule contient les caractéristiques techniques du meuble réfrigéré. Sa position et les caractéristiques sont indiquées dans: "Caractéristiques techniques" ("Fig. 20").

Les schémas électriques, les listes d'étalonnage des instruments de contrôle, les instructions d'installation et une copie de la Déclaration de Conformité sont disponibles sur le site <https://documents.eptarefrigeration.com>.

Le niveau de pression sonore générée par le fonctionnement du meuble est inférieur à 70 dB(A). Le meuble réfrigéré ne produit pas de vibrations nuisibles.

## 10.7 Chargement du produit

Mettre le meuble sous tension pour démarrer son cycle de refroidissement, en intervenant sur l'interrupteur-sectionneur général mural. Après environ 2 heures vous pouvez charger la marchandise dans le meuble réfrigéré.

Le meuble réfrigéré est en mesure de maintenir la température de la marchandise, mais non de la baisser. Les denrées alimentaires ne doivent donc être placées à l'intérieur du meuble que si elles ont déjà été refroidies à leur température de conservation respective. Ne jamais placer de produits chauds dans le meuble réfrigéré.

En présence d'un meuble avec vitres frontales, il est conseillé d'effectuer son nettoyage lorsque les clients ne se trouvent pas dans l'espace de vente. Lors du stockage de la marchandise, s'assurer que:

- le chargement est homogène par ses dimensions et la qualité de la marchandise.
- La marchandise ne bouche pas le flux d'air réfrigéré ("Fig. 21")
- La marchandise ne dépasse pas la limite de charge.
- La partie supérieure du meuble ne doit pas être chargée ("Fig. 25").

Charge maximale admissible uniformément distribuée:

- Sur le plateau de base: 225 kg/m<sup>2</sup>
- Sur les étagères: 140 kg/m<sup>2</sup>
- Sur le total des étagères : MAX 420 kg/m<sup>2</sup> (3 étagères) - 560 kg/m<sup>2</sup> (4 étagères)

Modello - Modèle - Model Modell - Modelo - Modelo	<b>PROFILE</b>	 epta refrigeration
Fabbricante - Constructeur - Manufacturer Hersteller - Fabricante - Fabricante	<b>Epta Spa</b> - Via Mecenate, 86 - 20138 Milano (MI) ITALIA Tel. 02/55403211 Telefax 02/55401023	<b>28/32</b>

## 10.8 Utilisation du meuble réfrigéré



Pour un bon fonctionnement, nous recommandons de vérifier que les portes ne sont pas ouvertes.

### Éclairage

L'éclairage du meuble réfrigéré est commandé par un interrupteur situé sur le meuble en bas à droite.

### Thermostat/thermomètre

Un thermostat/thermomètre à distance est placé sur le meuble en bas à droite pour le contrôle de la température ("Fig. 2", "Fig. 3", "Fig. 4").

Le thermostat à distance affiche la température à l'intérieur du boîtier et il permet de la contrôler avec les touches prévues.

### Configuration et inclinaison des présentoirs

Afin de garantir les performances correctes pour lesquelles le meuble a été conçu, la disposition des étagères dans les meubles doit respecter les configurations décrites (tableau "Tab. III" à la page "25").

Elles peuvent être inclinées en 4 positions en variant la position d'accrochage sur les montants postérieurs du meuble. ("Fig. 24").

Uniquement pour le modèle ouvert



Utiliser les couvercles de nuit ou le rideau de nuit, s'ils sont prévus, pendant les heures de fermeture du magasin. ("Fig. 22").

Uniquement pour modèle fermé



Ne jamais laisser les portes en verre supérieures ouvertes ou entrouvertes. Nous recommandons de vérifier fréquemment que toutes les portes soient fermées: vous éviterez d'inutiles consommations d'énergie et la formation de givre sur les parois obtenant par là même une meilleure conservation des produits exposés.

## 10.9 Nettoyage et entretien ordinaire

Il est recommandé d'assurer une bonne visibilité dans la zone d'intervention, éventuellement en utilisant une source d'éclairage supplémentaire.

### Nettoyage du meuble réfrigéré

Utiliser exclusivement de l'eau à la température maximum de 65°C et du savon ou un produit détergent ménager neutre dilué dans l'eau.

Pour les surfaces vitrées, utilisez uniquement des produits de nettoyage pour vitres. Il est conseillé d'éviter d'utiliser de l'eau, car elle risquerait de déposer du calcaire sur la surface du verre.

Veillez absolument de ne pas utiliser:

- d'éponges abrasives
- de produits inflammables ou abrasifs tels que l'alcool, l'acétone ou les solvants
- des détergents contenant des tensioactifs non ioniques, du citron ou du vinaigre (acide acétique)



Ne pas laver ou nettoyer la partie supérieure du meuble avec de l'eau ou des liquides.

Nettoyer **UNE FOIS PAR SEMAINE** toutes les parties extérieures du meuble.

Nettoyer **UNE FOIS PAR MOIS** toutes les parties intérieures du meuble, en suivant les instructions indiquées ci-dessous:

- Couper la tension électrique au meuble réfrigéré en intervenant sur l'interrupteur-sectionneur général mural ("Fig. 29").
- Vider le meuble réfrigéré en stockant la marchandise en chambre froide ou dans des réfrigérateurs aptes à maintenir leur température de conservation.
- Attendre que l'intérieur du meuble réfrigéré soit à la température ambiante avant de commencer le nettoyage
- Après avoir vérifié attentivement que l'intérieur du meuble est complètement sec, remettre en fonction l'appareil en le mettant sous tension.
- Attendre environ deux heures avant de charger la marchandise.

Modello - Modèle - Model Modell - Modelo - Modelo	<b>PROFILE</b>	 eptarefrigeration
Fabbricante - Constructeur - Manufacturer Hersteller - Fabricante - Fabricante	<b>Epta Spa</b> - Via Mecenate, 86 - 20138 Milano (MI) ITALIA Tel. 02/55403211 Telefax 02/55401023	<b>29/32</b>

Pour mettre le meuble hors service, débrancher l'alimentation et suivre la marche indiquée ci-dessus, en laissant les portes ouvertes (si disponible) pour éviter les odeurs désagréables.

**TOUS LES TROIS MOIS** effectuer le dégivrage du meuble afin d'éliminer la glace qui s'est éventuellement formée sur les ailettes de l'évaporateur en empêchant son bon fonctionnement. La durée et le nombre de dégivrages sont directement réglés d'origine. D'autres réglages éventuels sont exclusivement réservés au service après-vente. L'eau de dégivrage est collectée dans une évacuation spéciale. Vérifier périodiquement que l'eau de dégivrage s'écoule normalement. Si cela n'est pas, utilisez une sonde flexible et non pointue.

Intervenir de la manière indiquée pour le nettoyage **MENSUEL** des parties intérieures, mais dans ce cas il faudra prévoir un délai d'attente plus long afin que la glace fonde complètement.

## 10.10 Situations d'urgence

### Le meuble réfrigéré ne démarre pas ou s'arrête:

- Vérifier l'absence de blackout électrique.
- Vérifier que l'interrupteur général mural est branché.
- Vérifier que la fiche du meuble réfrigéré est branchée dans la prise secteur.

Si la coupure électrique n'est pas due à ces raisons, contactez le service après-vente agréé le plus proche, retirez complètement tous les produits et stockez-les immédiatement en chambre froide ou dans des réfrigérateurs aptes à maintenir la température de conservation.

### Le meuble réfrigéré ne refroidit pas suffisamment:

- S'assurer que le meuble est chargé correctement.
- Dégivrer le meuble et reprendre ensuite son fonctionnement normal, si cette opération n'a pas été effectuée depuis plus de trois mois.
- Vérifier que le meuble réfrigéré n'est pas placé près de sources de chaleur ou de courants d'air.
- Vérifier les conditions ambiantes indiquées au chapitre "Conditions ambiantes" ("Tab. II", Page"20").
- Vérifier que l'installation du meuble réfrigéré est horizontale à l'aide d'un niveau.

Si le meuble ne refroidit toujours pas, contactez le service après-vente agréé le plus proche.

### Le meuble réfrigéré est bruyant:

- Vérifier que les vis et les boulons sont parfaitement serrés.
- Vérifier que l'installation du meuble réfrigéré est horizontale à l'aide d'un niveau.

Si l'inconvénient persiste, contactez le service après-vente agréé le plus proche.

## 10.11 Service après-vente

En cas de nécessité d'intervention de techniciens, contactez immédiatement le fournisseur chez qui vous avez acheté le meuble réfrigéré.

En cas de nécessité d'utiliser des pièces de rechange, toujours contacter le service après-vente: demandez et assurez-vous que les pièces de rechange fournies sont d'origine.

Modello - Modèle - Model Modell - Modelo - Modelo	<b>PROFILE</b>	 epta refrigeration
Fabbricante - Constructeur - Manufacturer Hersteller - Fabricante - Fabricante	<b>Epta Spa</b> - Via Mecenate, 86 - 20138 Milano (MI) ITALIA Tel. 02/55403211 Telefax 02/55401023	<b>30/32</b>

EN

## 10.12 Démantèlement et élimination

IT

FR

DE

ES

PT

Conformément aux normes en matière d'élimination des déchets en vigueur dans les différents pays et pour le respect de l'environnement où nous vivons, veuillez trier les parties du meuble réfrigéré de manière à pouvoir les éliminer séparément ou éventuellement, les récupérer.

Toutes les parties qui composent le meuble réfrigéré ne sont pas assimilables à des déchets solides urbains, exception faite des parties métalliques qui ne figurent pas parmi les déchets spéciaux dans la plupart des pays européens.



Le système de réfrigération est à haute pression. Contactez le personnel expérimenté avant toute mise au rebut.

Ne jamais couper ou séparer les composants du circuit de réfrigération avant d'avoir vidangé le circuit et avoir fait récupérer le réfrigérant par des personnels qualifiés.

Modello - Modèle - Model Modell - Modelo - Modelo	<b>PROFILE</b>	 eptarefrigeration
Fabbricante - Constructeur - Manufacturer Hersteller - Fabricante - Fabricante	<b>Epta Spa</b> - Via Mecenate, 86 - 20138 Milano (MI) ITALIA Tel. 02/55403211 Telefax 02/55401023	<b>31/32</b>

## 11. AVERTISSEMENTS GÉNÉRAUX SUPPLÉMENTAIRES

### Instructions pour une installation et un entretien corrects

Les instructions d'utilisation et d'entretien sont indiquées dans le manuel de l'utilisateur disponible dans notre site web:  
[www.eptarefrigeration.com](http://www.eptarefrigeration.com).

Des instructions d'installation pour le personnel expérimenté sont disponibles:

- Après de notre réseau après-vente
- Dans certaines catégories de produits, sous forme papier, livrées avec le produit

### Informations sur le produit

Les informations produit (EPREL) sont disponibles en se connectant au site <https://eprel.eptarefrigeration.com> et en suivant les instructions indiquées pour accéder à la base de données.

### Garantie

Conformément à la loi, le produit est couvert par la garantie pendant une période de 12 mois, à moins d'accords différents explicitement signés par les parties.

### Services professionnels de réparation.

Les services sont fournis par notre réseau après-vente qui peut être consulté dans l'espace Contacts à l'adresse web [www.eptarefrigeration.com](http://www.eptarefrigeration.com).

### Pièces de rechange

Les pièces de rechange et les informations pour la réparation de l'appareil sont disponibles pendant au moins 8 ans après la mise hors production du produit à l'adresse web suivante:  
[www.epta-service.com/service](http://www.epta-service.com/service).

Les identifiants d'accès sont fournis en adressant une demande par e-mail à:  
[servicesupport@eptarefrigeration.com](mailto:servicesupport@eptarefrigeration.com).

### Informations importantes sur le gaspillage alimentaire

Il est recommandé de suivre attentivement les instructions de conservation figurant sur l'emballage des produits, ainsi que les indications fournies par les producteurs de produits alimentaires.

Par conséquent, les paramétrages de la température doivent être adaptés aux caractéristiques de conservation des produits alimentaires, conformément aux indications contenues dans notre documentation technique.

Toute utilisation incorrecte peut entraîner une détérioration.

### Conditions ambiantes

Cet appareil est destiné à fonctionner dans des environnements où la température et l'humidité se situent dans les limites indiquées dans le manuel d'utilisation.

### Instructions pour le désassemblage

Pour le désassemblage, veuillez vous adresser à des opérateurs professionnels.

Portant depuis toujours une attention particulière à l'environnement, le Groupe Epta met à la disposition des utilisateurs des manuels de démantèlement et de traitement des déchets, pouvant être téléchargés ci-dessous.

- Accéder au site [www.bonnetneve.com](http://www.bonnetneve.com)



- Accédez à la section **zone technique** de l'armoire.

Modello - Modèlo - Model Modell - Modelo - Modelo	<b>PROFILE</b>	 eptarefrigeration
Fabbricante - Constructeur - Manufacturer Hersteller - Fabricante - Fabricante	<b>Epta Spa</b> - Via Mecenate, 86 - 20138 Milano (MI) ITALIA Tel. 02/55403211 Telefax 02/55401023	<b>32/32</b>

## User Manual

- EN
- IT
- FR
- DE
- ES
- PT

### Autres informations

Pour plus d'informations, veuillez faire référence à [www.eptarefrigeration.com](http://www.eptarefrigeration.com) et à EPREL en scannant le code QR ci-contre ou sur l'étiquette énergie du produit.



### Limites d'application



Ce meuble réfrigéré a été conçu pour l'utilisation, le transport et le stockage jusqu'à une altitude maximum de 2000 m au-dessus du niveau de la mer.

#### Stockage:

- Température comprise entre 15°C et 50°C
- Humidité relative comprise entre 20% et 90%
- Temps maximum 6 mois

#### Transport:

- Température comprise entre 20°C et 70°C
- Humidité relative comprise entre 20% et 90%
- Temps maximum 2 mois

### Utilisation:

La classe climatique d'utilisation est indiquée sur la plaque matricule.

Vous trouverez ci-dessous un extrait de la norme de référence, qui clarifie la signification des caractères alphanumériques:

Classe climatique	Température du bulbe sec	Humidité relative
[-]	[°C]	[%]
0	20	50
1	16	80
8	24	55
2	22	65
3	25	60
4	30	55
6	27	70
5	40	40
7	35	75

EXEMPLE La classe climatique 3 signifie 25°C / 60%R.H.

### Performance



Les conditions environnementales extérieures nécessaires au bon fonctionnement du meuble sont indiquées sur la plaque matricule.

Les performances du meuble réfrigéré ne sont pas garanties hors de son utilisation normale.



La température minimale ne doit pas être inférieure à 16°C.

Modello - Modèle - Model Modell - Modelo - Modelo	<b>PROFILE</b>	 epta refrigeration
Fabbricante - Constructeur - Manufacturer Hersteller - Fabricante - Fabricante	<b>Epta Spa</b> - Via Mecenate, 86 - 20138 Milano (MI) ITALIA Tel. 02/55403211 Telefax 02/55401023	<b>4/32</b>

## User Manual

- EN
- IT
- FR
- DE**
- ES
- PT

## VERWENDETE SYMBOLE

 Symbol für ein Verbot: Verbieht bestimmte Handlungen.

 Gefahrensymbol: Regeln zur Unfallvermeidung für den Benutzer.

 Symbol für einen Warnhinweis: Möglicherweise kann ein Schaden am Gerät und/oder an einer der Komponenten entstehen.

 Symbol für einen Hinweis: Es folgen nützliche Informationen.

Modello - Modèle - Model Modell - Modelo - Modelo	<b>PROFILE</b>	 epta refrigeration
Fabbricante - Constructeur - Manufacturer Hersteller - Fabricante - Fabricante	<b>Epta Spa</b> - Via Mecenate, 86 - 20138 Milano (MI) ITALIA Tel. 02/55403211 Telefax 02/55401023	<b>5/32</b>

**VERZEICHNIS**

<b>1.</b>	<b>Einführung</b>	<b>6</b>	<b>EN</b>
<b>2.</b>	<b>Sicherheitshinweise</b>	<b>7</b>	<b>IT</b>
2.1	Allgemeine Hinweise	7	
2.2	Wartungshinweise für das Kühlmöbel	9	<b>FR</b>
2.3	Elektrische Warnhinweise	9	
2.4	Verbote	10	
<b>3.</b>	<b>Allgemeine Beschreibung</b>	<b>11</b>	<b>DE</b>
3.1	Schnittbilder	13	
<b>4.</b>	<b>Transport des Kühlmöbels</b>	<b>19</b>	<b>ES</b>
<b>5.</b>	<b>Umgebungsbedingungen</b>	<b>20</b>	<b>PT</b>
6.1	Modellreferenz / Bezeichnung	21	
<b>6.</b>	<b>Technische Eigenschaften</b>	<b>21</b>	
<b>7.</b>	<b>Verwendung des Kühlmöbels</b>	<b>22</b>	
<b>8.</b>	<b>Wartung des Möbels</b>	<b>24</b>	
8.1	Die Reinigung des Kühlmöbels	24	
<b>9.</b>	<b>Regalkonfiguration</b>	<b>25</b>	
<b>10.</b>	<b>Hinweise für den Nutzer</b>	<b>26</b>	
10.1	Beschreibung des Kühlmöbels	26	
10.2	Transport und Bewegung des Kühlmöbels	26	
10.3	Empfang und Lagerung des Möbels	26	
10.4	Installation und Umgebungsbedingungen	27	
10.5	Elektrischer Anschluss	27	
10.6	Technische Eigenschaften	27	
10.7	Die Befüllung des Kühlmöbels	27	
10.8	Verwendung des Kühlmöbels	28	
10.9	Reinigung und regelmäßige Wartung	28	
10.10	Gefahrensituationen	29	
10.11	Technischer Wartungsdienst	29	
10.12	Demontage und Entsorgung	30	
<b>11.</b>	<b>Allgemeine ergänzende Hinweise</b>	<b>31</b>	

Modello - Modèle - Model Modell - Modelo - Modelo	<b>PROFILE</b>	 eptarefrigeration
Fabbricante - Constructeur - Manufacturer Hersteller - Fabricante - Fabricante	<b>Epta Spa</b> - Via Mecenate, 86 - 20138 Milano (MI) ITALIA Tel. 02/55403211 Telefax 02/55401023	<b>6/32</b>

## 1. EINFÜHRUNG

Es wird empfohlen, den Inhalt des vorliegenden Handbuchs zu lesen und es gemeinsam mit dem Kühlmöbel aufzubewahren.

Der Hersteller lehnt jede Haftung für Personen- oder Sachschäden ab, die durch Nichtbeachtung der in diesem Handbuch enthaltenen Warnhinweise entstehen.

Dieses Benutzerhandbuch gilt für eine Produktfamilie, die in verschiedenen Konfigurationen und Größen erhältlich ist; die Leistungsdaten und Spezifikationen der einzelnen Modelle werden durch die Angaben auf dem Typenschild, die EG-Konformitätserklärung sowie durch das Energielabel und das zugehörige EPREL-Produktdatenblatt ergänzt.

Die Leistung jedes einzelnen Modells kann je nach spezifischer Konfiguration variieren. Das Energielabel und das Produktdatenblatt sind auch unter <https://eprel.eptarefrigeration.com> verfügbar, indem die auf dem Typenschild angegebene Seriennummer eingegeben wird.



Abb. N

Das vorliegende Handbuch enthält Informationen, die für die ordnungsgemäße Verwendung und Funktionsweise des Kühlmöbels notwendig sind.

Es enthält die folgenden Erläuterungen und Informationen:

- Eine Funktionsbeschreibung des Kühlmöbels, inklusive all seiner Komponenten
- Informationen über die für dieses Gerät geltenden Sicherheits- und Unfallverhütungsvorschriften
- Hinweise zur korrekten Verwendung des Kühlmöbels
- Hinweise für die korrekte, routinemäßige und planmäßige Wartung, einschließlich der Reinigungsarbeiten

Die folgenden Informationen sind nicht im Handbuch enthalten:

- Installationsanleitungen

Für die korrekte Installation des Kühlmöbels verweisen wir auf die folgenden Dokumente:

- Technical Manual
- Quick Reference Instructions

Das vorliegende Handbuch richtet sich an die folgenden Berufsgruppen:

- **QUALIFIZIERTE MITARBEITER:** Qualifizierte Personen, die mit dem Betrieb, der Einstellung, der Reinigung und der regelmäßigen Wartung des Möbels betraut sind
- **SPEZIALISIERTE TECHNIKER:** Techniker, die von der im Vertrag angegebenen Stelle (Hersteller/Vertragshändler/Lieferfirma) geschult und befugt sind, die folgenden Arbeiten auszuführen: Installation, außerordentliche Wartung, Reparatur, Austausch und Inspektion des Kühlmöbels

Die Bedienungsanleitung ist auch unter verfügbar: [www.eptarefrigeration.com](http://www.eptarefrigeration.com).

**Die geltenden Vorschriften und Zertifizierungen für dieses Kühlmöbel entnehmen Sie bitte der Konformitätserklärung.**

**Bewahren Sie die Gebrauchsanweisung und für den Fall des Verkaufs immer auf.**

Modello - Modèle - Model Modell - Modelo - Modelo	<b>PROFILE</b>	 epta refrigeration
Fabbricante - Constructeur - Manufacturer Hersteller - Fabricante - Fabricante	<b>Epta Spa</b> - Via Mecenate, 86 - 20138 Milano (MI) ITALIA Tel. 02/55403211 Telefax 02/55401023	<b>7/32</b>

## 2. SICHERHEITSHINWEISE

### 2.1 Allgemeine Hinweise



Die Bezeichnung des Geräts ist auf Seite "21".



Dieses Gerät ist für den Betrieb in der Umgebungsklasse 3 oder 4 ausgelegt; die Definition der Umgebungsklasse ist angegeben auf Seite "32".



Der Hersteller lehnt jede Haftung für Personen- oder Sachschäden ab, die durch Nichtbeachtung der in diesem Handbuch enthaltenen Warnhinweise entstehen. Jede Person, die dieses Kühlmöbel verwendet, ist dazu aufgefordert, das vorliegende Benutzerhandbuch zu lesen.



Alle Vorgänge der Handhabung, des Transports, der Montage und der Demontage während der Außerbetriebnahme sowie bei der Entsorgung dürfen ausschließlich von qualifiziertem Personal durchgeführt werden.



Der Arbeitgeber muss das Personal über die folgenden geltenden Vorschriften informieren: Über die Unfallgefahren, über die bestehenden Sicherheitsvorrichtungen für das Personal, über die Gefahren von Lärmemissionen und die allgemeinen Unfallverhütungsvorschriften.



Der technische Gebrauch der Kühltheke ist befugtem und geschultem Personal vorbehalten; Tätigkeiten zum technischen Gebrauch umfassen z. B. das Einschalten, Einstellen, Reinigen und Warten.



Die Nutzung des Kühlmöbels für nicht-technische Zwecke, wie z. B. das Öffnen der Türen zur Entnahme der ausgestellten Produkte, kann auch durch Kinder ab 8 Jahren oder durch Personen mit eingeschränkten körperlichen, sensorischen oder geistigen Fähigkeiten oder mangelnder Erfahrung und Kenntnis erfolgen, sofern sie beaufsichtigt wurden oder eine Einweisung in die sichere Verwendung des Geräts erhalten haben und die damit verbundenen Gefahren verstehen.

Kinder müssen beaufsichtigt werden, damit sie nicht mit dem Gerät spielen. Reinigung und Wartung dürfen nicht von Kindern ohne Aufsicht durchgeführt werden.



Jede andere nicht ausdrücklich in diesem Handbuch angegebene Verwendungen gelten als gefährlich. Soit kann der Hersteller nicht für Schäden haftbar gemacht werden, die durch falschen Anschluss, fehlerhafte oder nicht bestimmungsgemäße Verwendung verursacht wurden.



Das Kühlmöbel darf nur von Personen benutzt werden, die mit der entsprechenden, passenden Schutzkleidung ausgestattet sind.



Weisen Sie jeden, der das Kühlmöbel benutzt, auf die Position des Trennschalters hin.



Das Tragen von Handschuhen ist Vorschrift.



Das Entfernen von Schutzvorrichtungen oder von Teilen der Verkleidung, für das der Einsatz von Werkzeug erforderlich ist, ist ausschließlich qualifiziertem Personal vorbehalten.

EN

IT

FR

DE

ES

PT

Modello - Modèle - Model Modell - Modelo - Modelo	<b>PROFILE</b>	 epta refrigeration
Fabbricante - Constructeur - Manufacturer Hersteller - Fabricante - Fabricante	<b>Epta Spa</b> - Via Mecenate, 86 - 20138 Milano (MI) ITALIA Tel. 02/55403211 Telefax 02/55401023	<b>8/32</b>

## User Manual

EN



Sämtliche Arbeiten sind ausschließlich durch qualifiziertes Personal durchzuführen. Das Gerät muss vor jedem Eingriff von der Stromzufuhr getrennt werden.

IT

FR

DE

ES

PT



Eingriffe am Thermostat sind ausschließlich dem autorisierten technischen Kundendienst vorbehalten.



Wenden Sie sich bitte an das nächstgelegene autorisierte Servicezentrum, um spezielle Zusatzausstattungen montieren zu lassen.



Das Kühlmöbel darf keinen Witterungseinflüssen ausgesetzt werden.



Das Kühlmöbel darf keinem direkten oder indirekten Wasserstrahl ausgesetzt werden.



Berühren Sie das Kühlmöbel nicht mit nassen oder feuchten Händen oder Füßen. Benutzen Sie das Gerät niemals barfuß.



Achten Sie auf warme oder bewegliche Geräteteile. Diese sind mit einem entsprechenden Symbol gekennzeichnet.



Beschädigen Sie nicht den Kühlkreislauf.



Vermeiden Sie Flammen oder Funken im Inneren des Geräts.



Verwenden Sie im Falle eines Brandes ausschließlich Trockenlöschgeräte, verwenden Sie kein Wasser zum Löschen der Flammen.



Verwenden Sie keine elektrischen Geräte in den Fächern des Geräts zur Aufbewahrung von frischen oder gefrorenen Lebensmitteln, es sei denn, sie sind vom Hersteller empfohlen.



Lagern Sie in diesem Gerät keine explosiven oder gefährlichen Stoffe, wie z.B. unter Druck stehende Behälter mit entflammbarem Treibmittel.



Stellen Sie keine Flüssigkeitsbehälter auf und gießen Sie keine Flüssigkeiten auf die Theke.



Die Lüftungsöffnungen am Gehäuse des Geräts müssen stets frei bleiben.



Die Informationen zur maximalen Belastung der einzelnen Regaltypen finden Sie auf Seite "27".





Es dürfen keine Lasten auf das Kühlregal oben positioniert werden; unverpackte Lebensmittel sollten nicht direkt ins Regal gelegt werden. Diese sollten in dafür geeignete Behälter gelegt werden.

Modello - Modèle - Model Modell - Modelo - Modelo	<b>PROFILE</b>	 eptarefrigeration
Fabbricante - Constructeur - Manufacturer Hersteller - Fabricante - Fabricante	<b>Epta Spa</b> - Via Mecenate, 86 - 20138 Milano (MI) ITALIA Tel. 02/55403211 Telefax 02/55401023	<b>9/32</b>

## 2.2 Wartungshinweise für das Kühlmöbel

 Wartungsarbeiten dürfen ausschließlich von befugtem Personal durchgeführt werden.

 Der Zugriff auf die elektrischen Komponenten und/oder auf Teile, die den Einsatz von Werkzeug erfordern, ist qualifizierten Technikern vorbehalten.

 Vor der Durchführung von Wartungs- oder Reinigungsarbeiten muss die Stromzufuhr zum Kühlmöbel über Hauptschalter unterbrochen werden.

 Achten Sie auf warme oder bewegliche Geräteteile. Diese sind mit einem entsprechenden Symbol gekennzeichnet.

 Das Tragen von Handschuhen ist Vorschrift.

 Es ist wichtig, Art und Häufigkeit der für einen sicheren Betrieb erforderlichen Inspektionen und Wartungsarbeiten, einschließlich der vorbeugenden Wartungsmaßnahmen, einzuhalten, wie im Abschnitt "Reinigung und regelmäßige Wartung" auf Seite "28".

## 2.3 Elektrische Warnhinweise

 Vergewissern Sie sich, dass die Versorgungsspannung den Angaben auf dem Typenschild des Kühlmöbels entspricht.

 Die Elektroinstallation muss von fachkundigen Technikern fachgerecht ausgeführt werden.

 Die Abdeckung der Schalttafel darf nur durch qualifizierte Techniker entfernt werden.

 Gemäß den Installationsvorschriften muss das Stromversorgungsnetz über eine allpolige Trennvorrichtung verfügen, die unter den Betriebsbedingungen der Überspannungskategorie III die vollständige Trennung vom Netz gewährleistet.

 Die Installation des Kühlmöbels muss gemäß den Anweisungen des Herstellers durch qualifiziertes Personal erfolgen. Dabei müssen die im jeweiligen Bestimmungsland des Kühlmöbels geltenden Vorschriften für elektrische Betriebsmittel eingehalten werden.

 Eine fehlerhafte Installation des Kühlmöbels kann Schäden an Personen, Tieren oder Dingen verursachen, für die der Hersteller nicht haftbar gemacht werden kann.

 Wenn das Netzkabel beschädigt ist, muss es von autorisiertem Servicepersonal ersetzt werden, um Gefahren zu vermeiden. Versuchen Sie nicht, das Kabel zu reparieren.

 Versorgen Sie die Kühlmöbel nicht mit Strom, wenn sie beschädigt ist. Wenden Sie sich im Zweifelsfall an den Kundendienst oder Ihren Händler.

EN

IT

FR

DE

ES

PT

Modello - Modèle - Model Modell - Modelo - Modelo	<b>PROFILE</b>	 <small>eptarefrigeration</small>
Fabbricante - Constructeur - Manufacturer Hersteller - Fabricante - Fabricante	<b>Epta Spa</b> - Via Mecenate, 86 - 20138 Milano (MI) ITALIA Tel. 02/55403211 Telefax 02/55401023	<b>10/32</b>

## 2.4 Verbote

 Es ist verboten, andere als die vom Hersteller im Kühlmöbel mitgelieferten Geräte zu verwenden, um den Abtauvorgang zu beschleunigen.

 Das Entfernen der Schalttafelabdeckung oder das Öffnen von Abdeckungen, die den Einsatz von Werkzeug erfordern, ist für nicht qualifiziertes Personal verboten.

 Es ist verboten, das Kühlmöbel zur Aufbewahrung und/oder Präsentation von explosiven, entflammaren oder ätzenden Stoffen einzusetzen, wie z. B. Sprühdosen mit entflammarem Treibmittel.

 Das Kühlmöbel darf nicht für die Aufbewahrung und/oder Auslage von Arzneimitteln verwendet werden.

 Es ist verboten, das Kühlmöbel in einer Umgebung aufzustellen, in der sich explosive, gasförmige Stoffe befinden.

 Es ist verboten, das Typenschild des Kühlmöbels zu entfernen.

 Das Betreten der Theke oder der Thekenstoßstange ist verboten.

 Der Austausch von Bauteilen und/oder die Veränderung des Kühlgeräts, die nicht den Angaben des Herstellers entsprechen, sowie der Austausch von Originalersatzteilen durch andere, nicht vom Hersteller zugelassene Teile, ist verboten und führt zum Verlust der Garantiesansprüche.

Modello - Modèle - Model Modell - Modelo - Modelo	<b>PROFILE</b>	 epta refrigeration
Fabbricante - Constructeur - Manufacturer Hersteller - Fabricante - Fabricante	<b>Epta Spa</b> - Via Mecenate, 86 - 20138 Milano (MI) ITALIA Tel. 02/55403211 Telefax 02/55401023	<b>11/32</b>

### 3. ALLGEMEINE BESCHREIBUNG

Offen



Abb. 2

1. Typenschild
2. Obere Beleuchtung
3. Nachtblende
4. Auslagenfächer
5. Seitliche Gläser
6. Lichtschalter
7. Fernthermostat

Geschlossen (Glastüren)



Abb. 3

1. Typenschild
2. Obere Beleuchtung
3. Bietet in Glas
4. Auslagenfächer
5. Seitliche Gläser
6. Lichtschalter
7. Fernthermostat

EN

IT

FR

DE

ES

PT

Modello - Modèle - Model Modell - Modelo - Modelo	<b>PROFILE</b>	 epta refrigeration
Fabbricante - Constructeur - Manufacturer Hersteller - Fabricante - Fabricante	<b>Epta Spa</b> - Via Mecenate, 86 - 20138 Milano (MI) ITALIA Tel. 02/55403211 Telefax 02/55401023	<b>12/32</b>

## User Manual

EN

IT

FR

DE

ES

PT

### Geschlossen (Schiebetüren aus Glas)



Abb. 4

1. Typenschild
2. Obere Beleuchtung
3. Verschiebbare Türen aus Glas
4. Auslagenfächer
5. Seitliche Gläser
6. Lichtschalter
7. Fernthermostat

Modello - Modèle - Model Modell - Modelo - Modelo	<h1>PROFILE</h1>	
Fabbricante - Constructeur - Manufacturer Hersteller - Fabricante - Fabricante	<b>Epta Spa</b> - Via Mecenate, 86 - 20138 Milano (MI) ITALIA Tel. 02/55403211 Telefax 02/55401023	<b>13/32</b>

## 3.1 Schnittbilder

### H20Offen

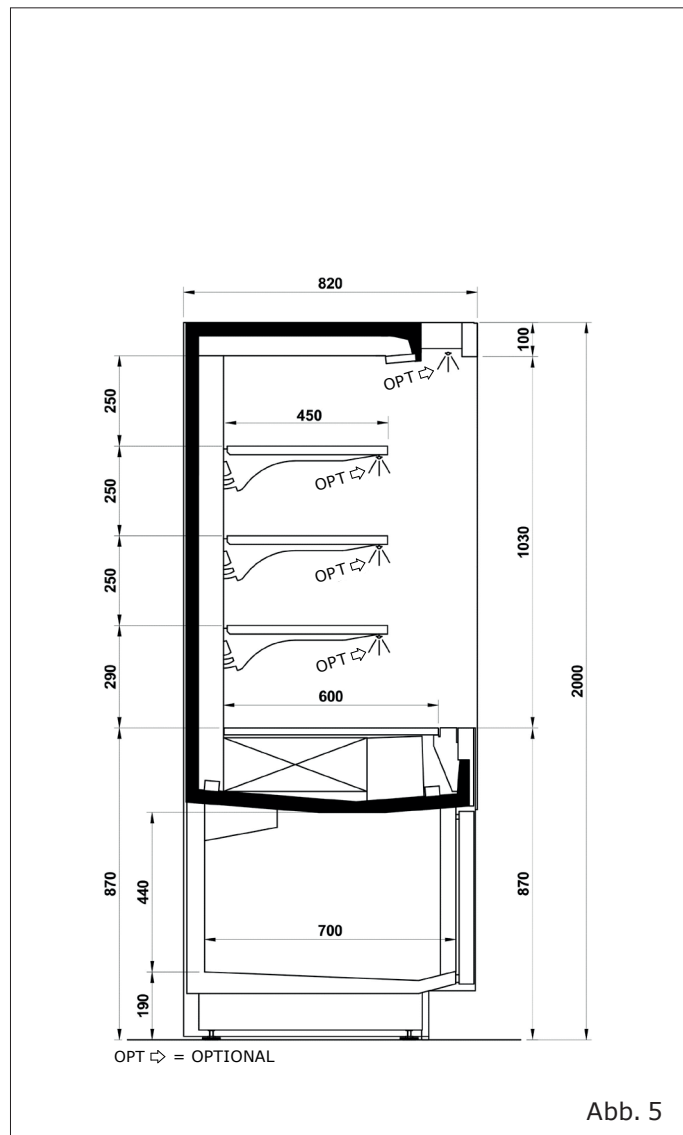

### H20Offen mit Haken

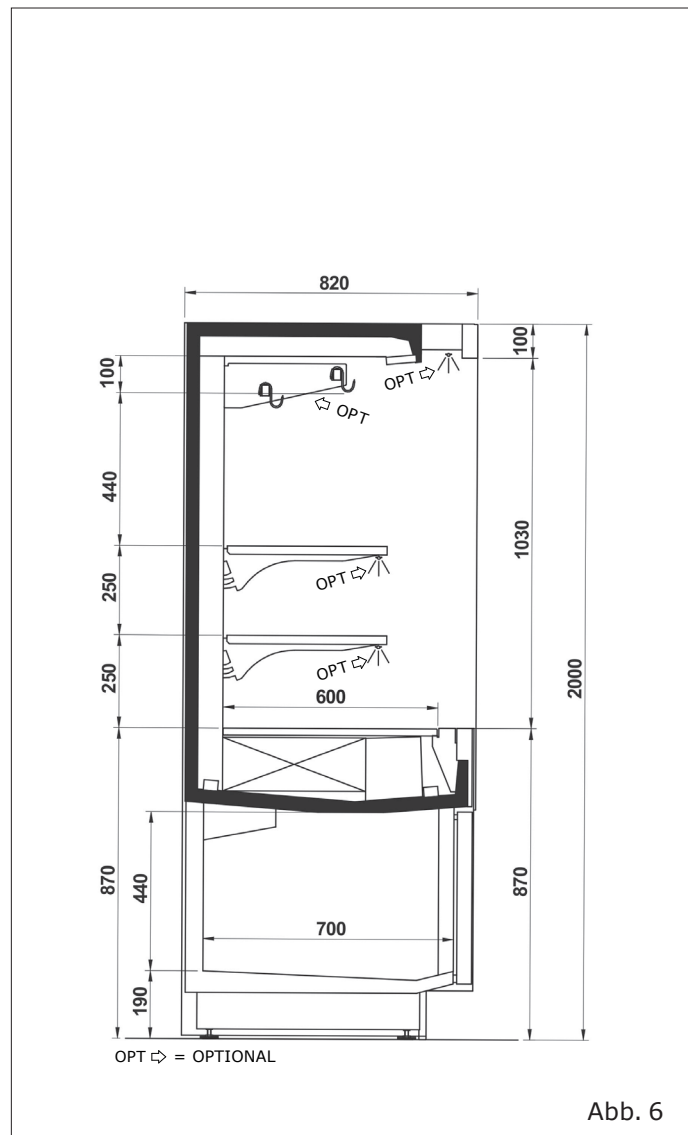

EN

IT

FR

DE

ES

PT

Modello - Modèle - Model Modell - Modelo - Modelo	<b>PROFILE</b>	 epta refrigeration
Fabbricante - Constructeur - Manufacturer Hersteller - Fabricante - Fabricante	<b>Epta Spa</b> - Via Mecenate, 86 - 20138 Milano (MI) ITALIA Tel. 02/55403211 Telefax 02/55401023	<b>14/32</b>

User Manual

- EN
- IT
- FR
- DE
- ES
- PT

**H20Geschlossen (Glastüren)**

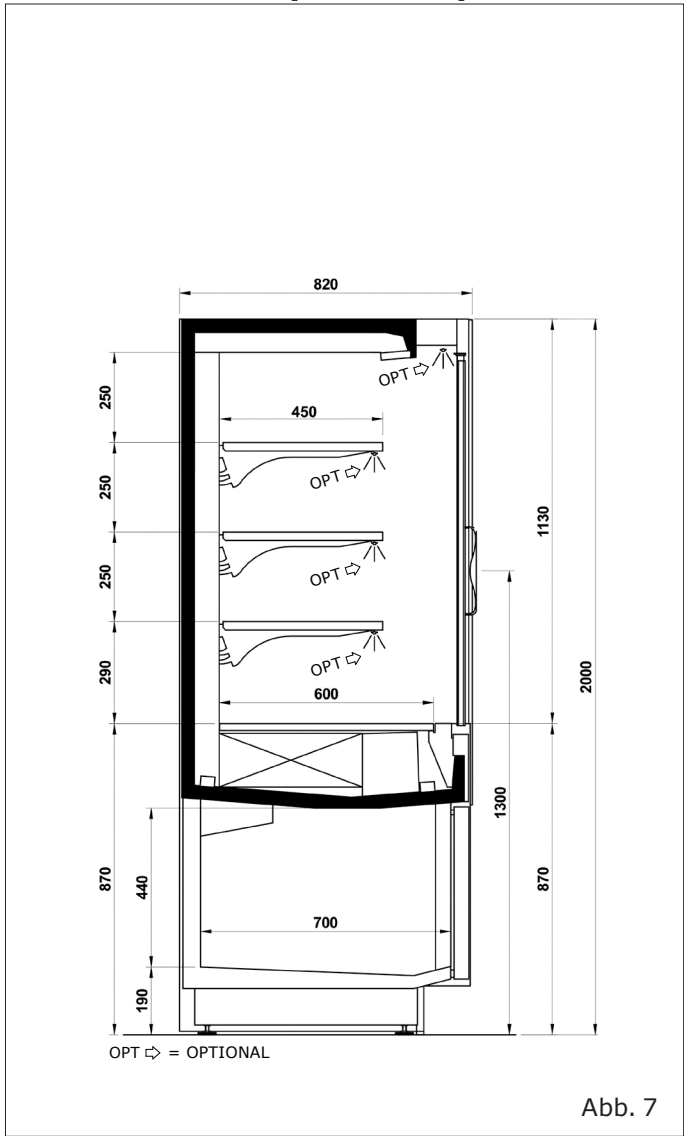

**H20Geschlossen mit Haken (Glastüren)**

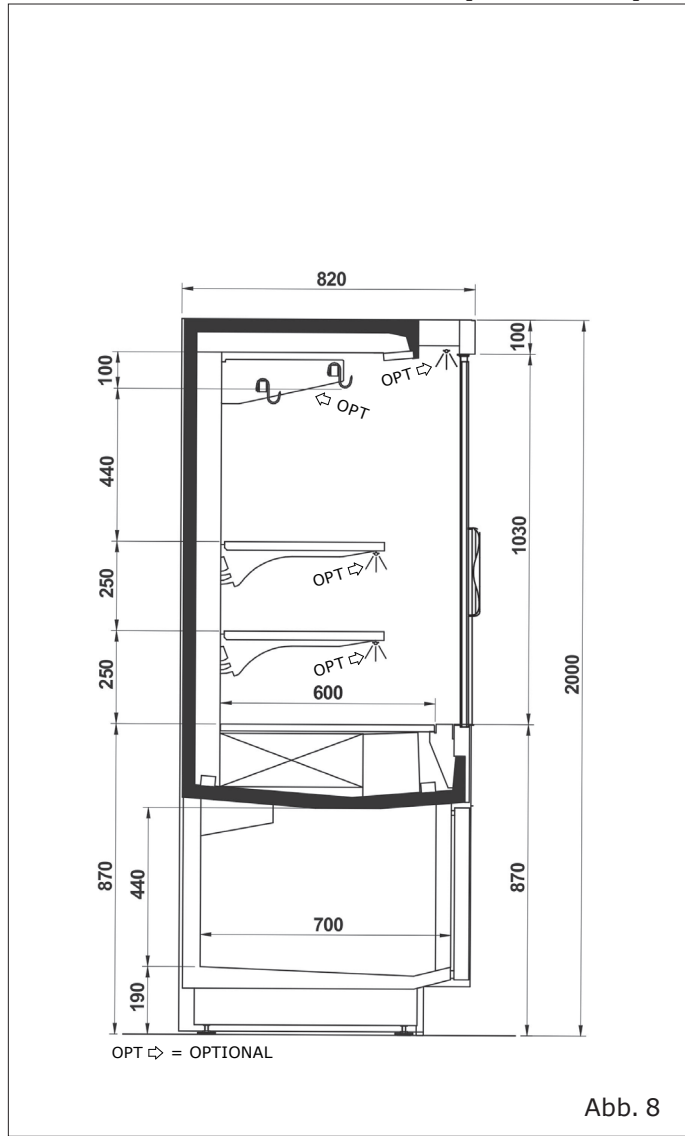

Modello - Modèle - Model Modell - Modelo - Modelo	<h1>PROFILE</h1>	
Fabbricante - Constructeur - Manufacturer Hersteller - Fabricante - Fabricante	<b>Epta Spa</b> - Via Mecenate, 86 - 20138 Milano (MI) ITALIA Tel. 02/55403211 Telefax 02/55401023	<b>15/32</b>

## H20Geschlossen (Schiebetüren aus Glas)

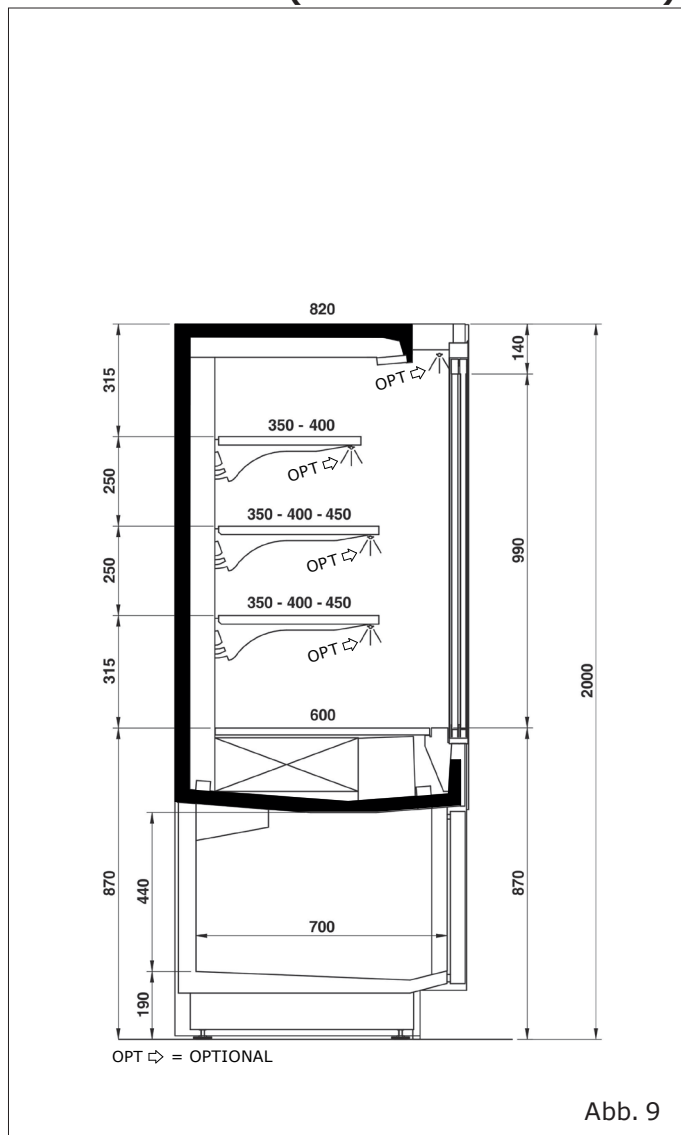

## H22Offen

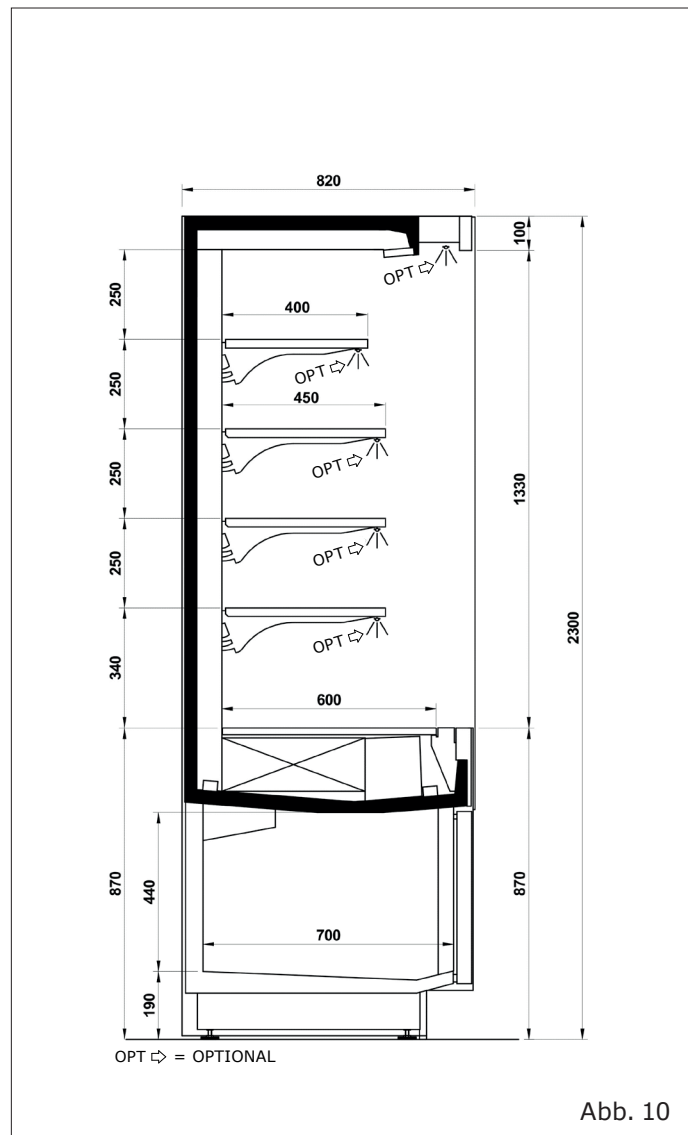

EN

IT

FR

DE

ES

PT

Modello - Modèle - Model Modell - Modelo - Modelo	<b>PROFILE</b>	 epta refrigeration
Fabbricante - Constructeur - Manufacturer Hersteller - Fabricante - Fabricante	<b>Epta Spa</b> - Via Mecenate, 86 - 20138 Milano (MI) ITALIA Tel. 02/55403211 Telefax 02/55401023	<b>16/32</b>

User Manual

- EN
- IT
- FR
- DE
- ES
- PT

### H22Offen mit Haken

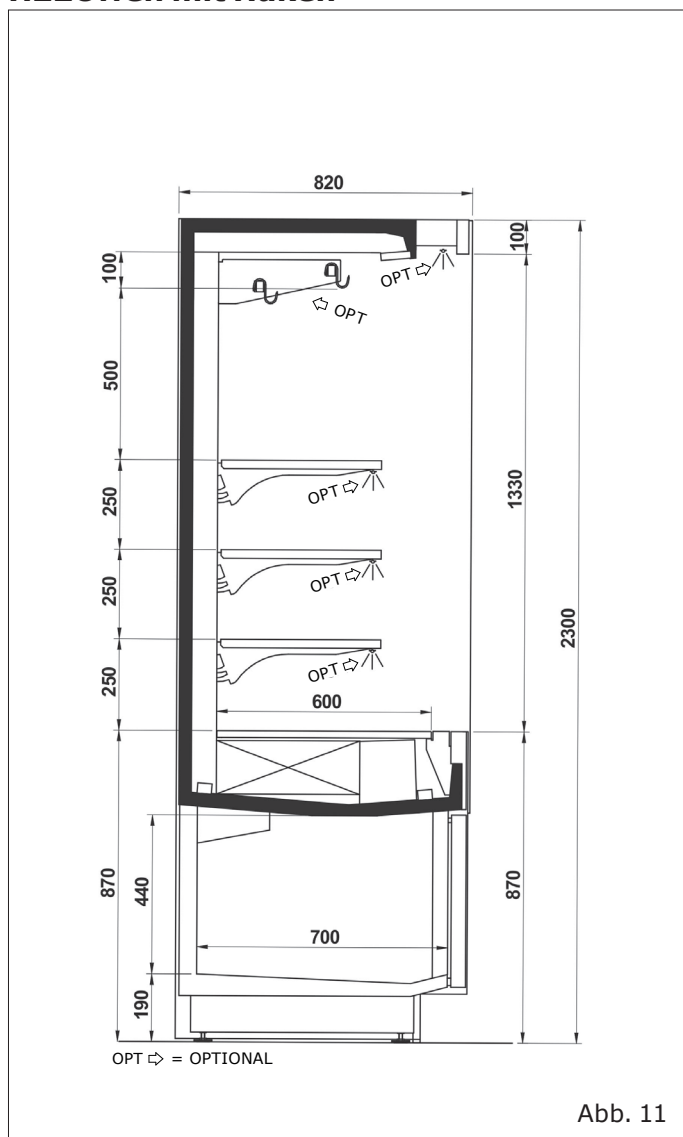

### H22Geschlossen (Glastüren)

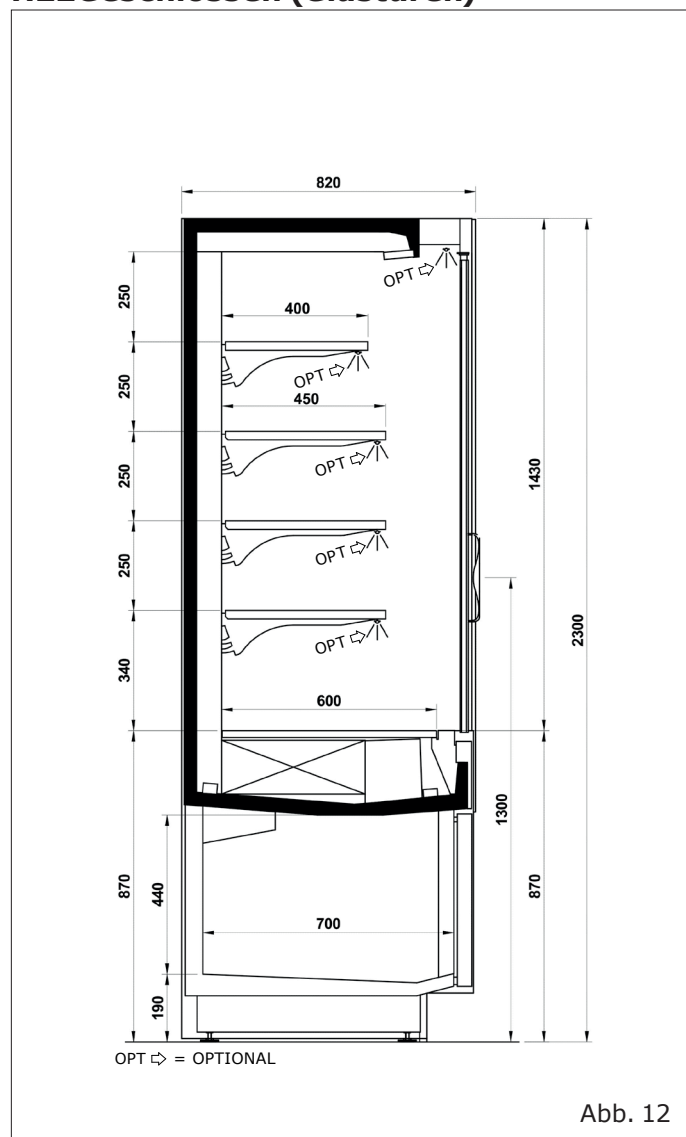

Modello - Modèle - Model Modell - Modelo - Modelo	<h1>PROFILE</h1>	
Fabbricante - Constructeur - Manufacturer Hersteller - Fabricante - Fabricante	<b>Epta Spa</b> - Via Mecenate, 86 - 20138 Milano (MI) ITALIA Tel. 02/55403211 Telefax 02/55401023	<b>17/32</b>

## H22Geschlossen mit Haken (Glastüren)

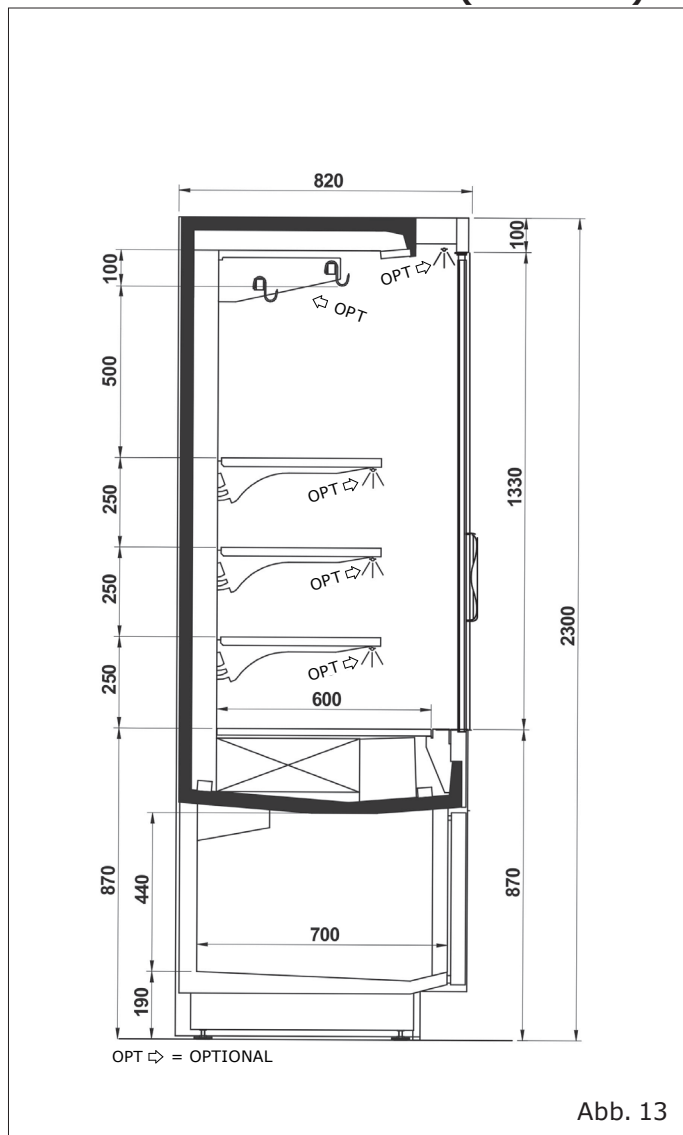

## H22Geschlossen (Schiebetüren aus Glas)

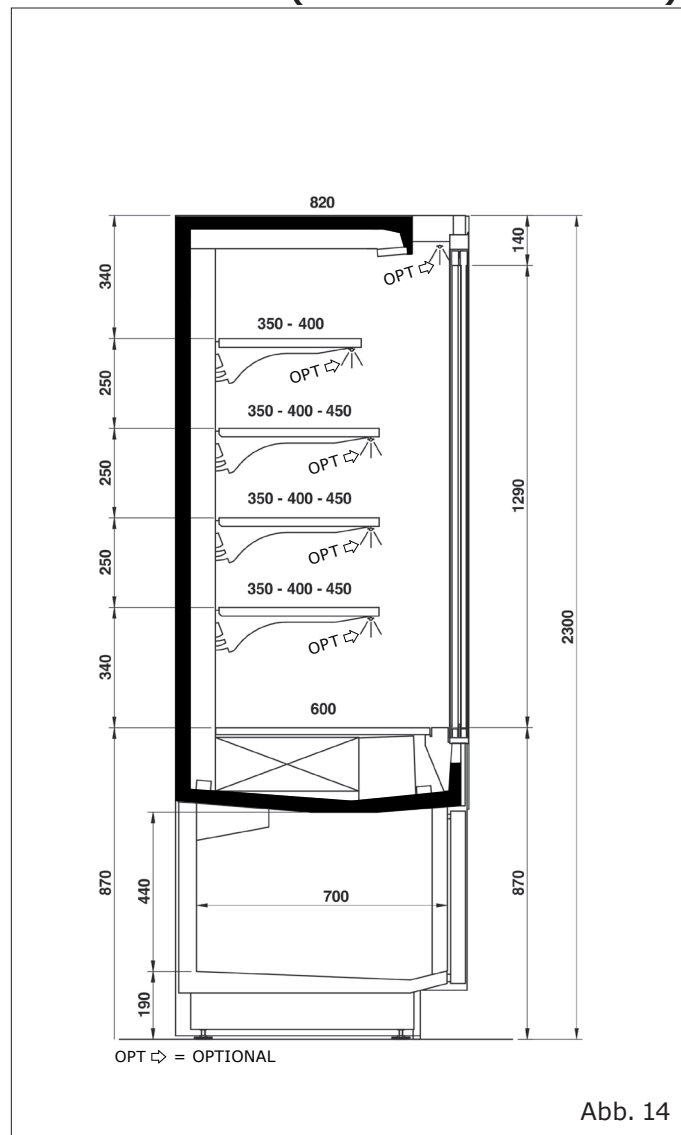

EN

IT

FR

DE

ES

PT

Modello - Modèle - Model Modell - Modelo - Modelo	<h1>PROFILE</h1>	
Fabbricante - Constructeur - Manufacturer Hersteller - Fabricante - Fabricante	<b>Epta Spa</b> - Via Mecenate, 86 - 20138 Milano (MI) ITALIA Tel. 02/55403211 Telefax 02/55401023	<b>18/32</b>

User Manual

- EN
- IT
- FR
- DE
- ES
- PT

## H26Offen

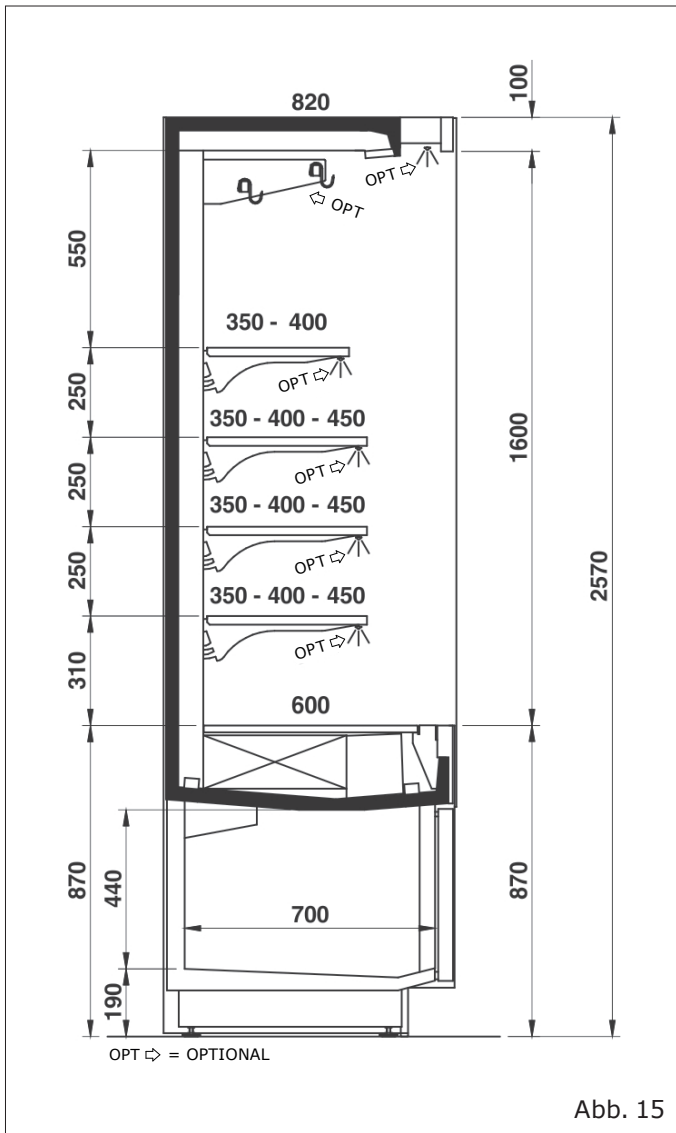

Modello - Modèle - Model Modell - Modelo - Modelo	<b>PROFILE</b>	
Fabbricante - Constructeur - Manufacturer Hersteller - Fabricante - Fabricante	<b>Epta Spa</b> - Via Mecenate, 86 - 20138 Milano (MI) ITALIA Tel. 02/55403211 Telefax 02/55401023	<b>19/32</b>

## 4. TRANSPORT DES KÜHLMÖBELS



### 1. Hebepunkte

**Tab. I**

Höhe	Länge	Gewicht (kg)	Gewicht mit Verpackung (kg)
2000	1250	85	95
	1875	215	240
	2500	365	400
2300	1250	100	120
	1875	250	280
	2500	400	440
2500	1250	115	135
	1875	285	315
	2500	435	475

Modello - Modèle - Model Modell - Modelo - Modelo	<b>PROFILE</b>	 epta refrigeration
Fabbricante - Constructeur - Manufacturer Hersteller - Fabricante - Fabricante	<b>Epta Spa</b> - Via Mecenate, 86 - 20138 Milano (MI) ITALIA Tel. 02/55403211 Telefax 02/55401023	<b>20/32</b>

- EN
- IT
- FR
- DE
- ES
- PT

## 5. UMGEBUNGSBEDINGUNGEN



Abb. 18

Tab. II

Eigenschaften	
Art des Aufstellortes	Geschlossen
Temperatur	25°C
Relative Luftfeuchtigkeit	60 %
Beleuchtung	600 lx



Abb. 19

Modello - Modèle - Model Modell - Modelo - Modelo	<b>PROFILE</b>	
Fabbricante - Constructeur - Manufacturer Hersteller - Fabricante - Fabricante	<b>Epta Spa</b> - Via Mecenate, 86 - 20138 Milano (MI) ITALIA Tel. 02/55403211 Telefax 02/55401023	<b>21/32</b>

## 6. TECHNISCHE EIGENSCHAFTEN

 <small>EPTA S.p.A. Via Mecenate, 86 20138 Milano - Italy</small>		<div style="border: 1px dashed black; padding: 5px;"> <span style="border: 1px solid black; border-radius: 50%; padding: 2px;">12</span> </div>			
<div style="border: 1px dashed black; padding: 5px;"> <span style="border: 1px solid black; border-radius: 50%; padding: 2px;">1</span> <span style="border: 1px solid black; border-radius: 50%; padding: 2px; margin-left: 100px;">2</span> </div>		<div style="border: 1px dashed black; padding: 5px;"> <span style="border: 1px solid black; padding: 2px;">SN</span> <span style="border: 1px solid black; border-radius: 50%; padding: 2px;">13</span> <span style="border: 1px solid black; padding: 2px; margin-left: 20px;">REF</span> <span style="border: 1px solid black; border-radius: 50%; padding: 2px;">15</span> <span style="border: 1px solid black; padding: 2px; margin-left: 20px;"></span> <span style="border: 1px solid black; border-radius: 50%; padding: 2px;">14</span> <span style="border: 1px solid black; padding: 2px; margin-left: 20px;"></span> <span style="border: 1px solid black; border-radius: 50%; padding: 2px;">16</span> </div>			
<small>RATED BEMESSUNG ASSIGNÉ NOMINALE NOMINAL</small>	<div style="border: 1px dashed black; padding: 5px;"> <span style="border: 1px solid black; border-radius: 50%; padding: 2px;">3</span> <span style="border: 1px solid black; border-radius: 50%; padding: 2px; margin-left: 20px;">4</span> </div>	<div style="border: 1px dashed black; padding: 5px;"> <span style="border: 1px solid black; border-radius: 50%; padding: 2px;">5</span> <span style="border: 1px solid black; border-radius: 50%; padding: 2px; margin-left: 20px;">6</span> </div>	<small>REFRIGERANT KÄLTEMITTEL RÉFRIGÉRANT REFRIGÉRANTE REFRIGERANTE</small>	<div style="border: 1px dashed black; padding: 5px;"> <span style="border: 1px solid black; border-radius: 50%; padding: 2px;">17</span> <span style="border: 1px solid black; border-radius: 50%; padding: 2px; margin-left: 20px;">18</span> </div>	<div style="border: 1px dashed black; padding: 5px;"> <span style="border: 1px solid black; border-radius: 50%; padding: 2px;">19</span> <span style="border: 1px solid black; border-radius: 50%; padding: 2px; margin-left: 20px;">20</span> </div>
<small>DEFROSTING ABTAUUNG DÉGIVRAGE SBRINAMENTO DESCONGELAMIENTO</small>	<div style="border: 1px dashed black; padding: 5px;"> <span style="border: 1px solid black; border-radius: 50%; padding: 2px;">7</span> <span style="border: 1px solid black; border-radius: 50%; padding: 2px; margin-left: 20px;">8</span> </div>	<small>CLIMATIC CLASS KLIMAKLASSE CLASSE CLIMATIQUE CLASSE CLIMATICA CLASE CLIMÁTICA</small>		<div style="border: 1px dashed black; padding: 5px;"> <span style="border: 1px solid black; border-radius: 50%; padding: 2px;">21</span> </div>	
<small>HEATING SYSTEMS HEIZUNGSSYSTEME SYSTEMES CHAUFFANTS SISTEMI DI RISCALDAMENTO SISTEMA DE CALEFACCIÓN</small>	<div style="border: 1px dashed black; padding: 5px;"> <span style="border: 1px solid black; border-radius: 50%; padding: 2px;">9</span> </div>		<small>INSULATION BLOWING GAS ISOLATIONS GAS (BLÄHGAS) AGENT MOUSSANT D'ISOLATION GAS ESPANDENTE ISOLAMENTO AGENTE ESPUMANTE</small>		<div style="border: 1px dashed black; padding: 5px;"> <span style="border: 1px solid black; border-radius: 50%; padding: 2px;">22</span> </div>
	<div style="border: 1px dashed black; padding: 5px;"> <span style="border: 1px solid black; border-radius: 50%; padding: 2px;">10</span> </div>		<small>PROTECTION INDEX SCHÜTZART INDEX DE LA PROTECTION INDICE DI PROTEZIONE ÍNDICE DE PROTECCIÓN</small>		<div style="border: 1px dashed black; padding: 5px;"> <span style="border: 1px solid black; border-radius: 50%; padding: 2px;">23</span> </div>
	<small>Read Operator's Manual available at <a href="http://www.eptarefrigeration.com">www.eptarefrigeration.com</a> or calling: +39 0437 968379</small>		<div style="border: 1px dashed black; padding: 5px;"> <span style="border: 1px solid black; border-radius: 50%; padding: 2px;">11</span> </div>	<div style="border: 1px dashed black; padding: 5px;"> <span style="border: 1px solid black; border-radius: 50%; padding: 2px;">24</span> </div>	

Abb. 20

- |  |   |
|--|---|
| <ol style="list-style-type: none"> <li>1. Produktherkunft</li> <li>2. Hergestellt in "Herstellungsland"</li> <li>3. Nennspannung</li> <li>4. Nennleistung</li> <li>5. Nennfrequenz</li> <li>6. Nennstrom</li> <li>7. Abtauleistung</li> <li>8. Strom für die Abtauautomatik</li> <li>9. Heizsystem</li> <li>10. Beleuchtungssystem</li> <li>11. Betriebshandbuch</li> <li>12. Barcode</li> </ol> | <ol style="list-style-type: none"> <li>13. Seriennummer</li> <li>14. Herstellungsdatum</li> <li>15. Hat Code</li> <li>16. Modell/Bezeichnung</li> <li>17. Kältemittelart 1</li> <li>18. Kältemittelmasse 1</li> <li>19. Kältemittelart 2</li> <li>20. Kältemittelmasse 2</li> <li>21. Klimaklasse</li> <li>22. Isolierung der Kältemittelleitung</li> <li>23. Schutzklasse</li> <li>24. Zertifizierungskennzeichen</li> </ol> |
|--|---|

### 6.1 Modellreferenz / Bezeichnung

Die Tabelle erläutert, wie der Modellcode zu lesen ist, und gibt die relevanten kommerziellen Informationen für jeden Teil der Referenz an (siehe Etikettenfeld Nummer: "16").

#### PROFILE xxx angegeben (Kühlmöbel)

Referenz / Bezeichnung	Beschreibung	Kommerzielle Informationen
Profile	Name	Profile
xxx	Länge	125(1250), 188(1875), 250(2500)

beispiel:  
Profile125 = Profile 1250

Modello - Modèle - Model Modell - Modelo - Modelo	<b>PROFILE</b>	
Fabbricante - Constructeur - Manufacturer Hersteller - Fabricante - Fabricante	<b>Epta Spa</b> - Via Mecenate, 86 - 20138 Milano (MI) ITALIA Tel. 02/55403211 Telefax 02/55401023	<b>22/32</b>

## 7. VERWENDUNG DES KÜHLMÖBELS



 Nicht zudecken

Nur für offenes Modell

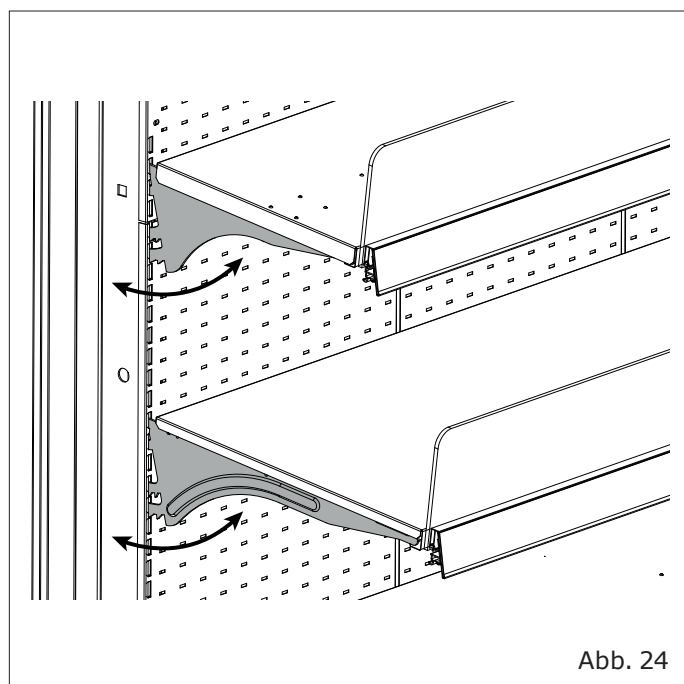

Neigung der facher: 0° - 7° - 14° - 21°

<p>Modello - Modèle - Model Modell - Modelo - Modelo</p>	<h1>PROFILE</h1>	
<p>Fabbricante - Constructeur - Manufacturer Hersteller - Fabricante - Fabricante</p>	<p><b>Epta Spa</b> - Via Mecenate, 86 - 20138 Milano (MI) ITALIA Tel. 02/55403211 Telefax 02/55401023</p>	<p><b>23/32</b></p>



- EN
- IT
- FR
- DE
- ES
- PT

Modello - Modèle - Model Modell - Modelo - Modelo	<b>PROFILE</b>	
Fabbricante - Constructeur - Manufacturer Hersteller - Fabricante - Fabricante	<b>Epta Spa</b> - Via Mecenate, 86 - 20138 Milano (MI) ITALIA Tel. 02/55403211 Telefax 02/55401023	<b>24/32</b>

- EN
- IT
- FR
- DE
- ES
- PT

## 8. WARTUNG DES MÖBELS

### 8.1 Die Reinigung des Kühlmöbels

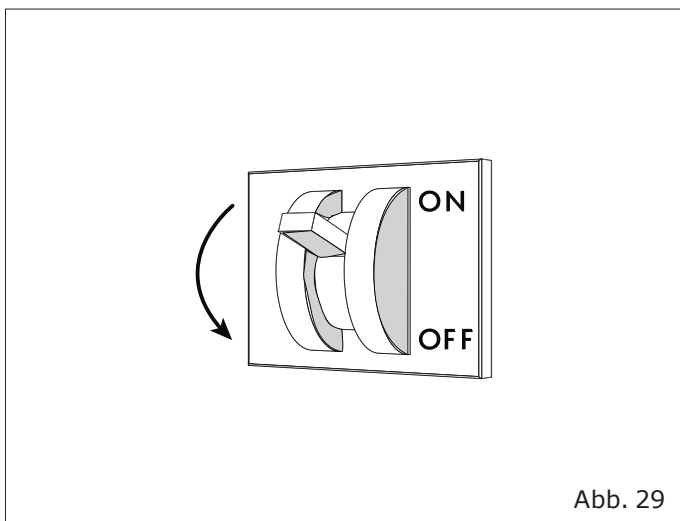

Modello - Modèle - Model Modell - Modelo - Modelo	<b>PROFILE</b>	 epta refrigeration
Fabbricante - Constructeur - Manufacturer Hersteller - Fabricante - Fabricante	<b>Epta Spa</b> - Via Mecenate, 86 - 20138 Milano (MI) ITALIA Tel. 02/55403211 Telefax 02/55401023	<b>25/32</b>

## 9. REGALKONFIGURATION

Tab. III

Regalkonfiguration mit einer Tiefe			
Ebene	Mit Haken	Ohne Haken	H20
1	x	x	350-400-450 350-400-450
2	x	x	350-400-450 350-400-451
3	x	-	350-400-450 350-400-452

Regalkonfiguration mit einer Tiefe			
Ebene	Mit Haken	Ohne Haken	H23
1	x	x	350-400-450 350-400-450
2	x	x	350-400-450 350-400-451
3	x	x	350-400-450 350-400-452
4	x	-	350-400-450 350-400-453

Modello - Modèle - Model Modell - Modelo - Modelo	<b>PROFILE</b>	
Fabbricante - Constructeur - Manufacturer Hersteller - Fabricante - Fabricante	<b>Epta Spa</b> - Via Mecenate, 86 - 20138 Milano (MI) ITALIA Tel. 02/55403211 Telefax 02/55401023	<b>26/32</b>

## 10. HINWEISE FÜR DEN NUTZER

### 10.1 Beschreibung des Kühlmöbels

Das Kühlmöbel wurde so geplant und hergestellt, daß es für die Aufbewahrung von frischen, verpackten Lebensmitteln, Getränken und Milchprodukten geeignet ist.

TEMPERATURKLASSE (gemäß EN ISO 23953-2):

- Offen H20/H23: 3M1/3M2, H26: 3M2
- Geschlossen H20/H23/H26: 3M1

Die allgemeinen Eigenschaften und die Abmessungen sind in den Abbildungen und in den Abschnitten der aufgeführt: "Allgemeine Beschreibung" (ab S. "11" bis S. "18").

Die empfohlenen Temperatureinstellungen für jedes Fach zur optimalen Lagerung von Lebensmitteln sind im EPREL-Produktdatenblatt angegeben oder durch Aufruf der Website <https://eprel.eptarefrigeration.com> und Befolgung der dort angegebenen Anweisungen für den Datenbankzugang verfügbar.

Beachten Sie, dass bei Transport, Handling, Anlieferung, Lagerung, Aufstellung, Beladung, Benutzung, Reinigung und Wartung sowie bei der Demontage die Gefahr besteht, dass das Gerät umkippt ("Abb. 31").



Abb. 31

### 10.2 Transport und Bewegung des Kühlmöbels

Das Möbel befindet sich in einer speziellen Verpackung mit einem Transportsockel für den Gabelstapler.

Verwenden Sie für die Bewegung des Möbels:

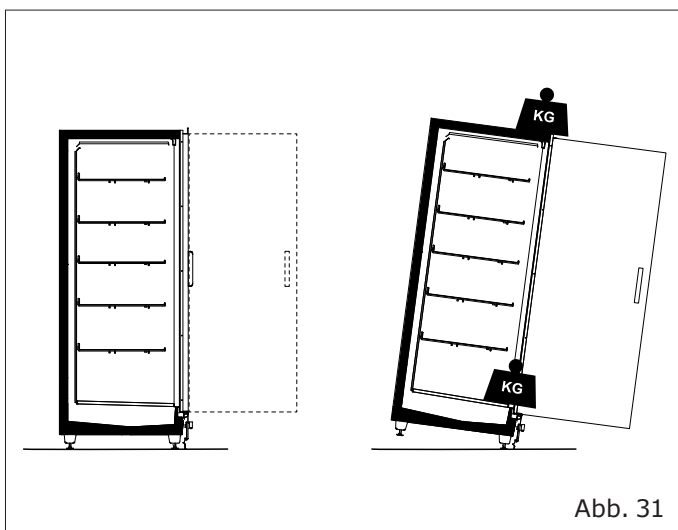
- Ausschließlich einen speziell geeigneten oder gleichwertigen Transportsockel
- Einen manuellen oder elektrischen Hubwagen, der für das Anheben des Möbels geeignet ist und über die vorgeschriebenen Eigenschaften verfügt

Das Gerätegewicht (Leergewicht und mit Verpackung) und die Abmessungen der Verpackung sind im Abschnitt aufgeführt "Transport des Kühlmöbels" (Tabelle "Tab. I" und Abb. auf S. "19").

Die Durchführung der Positionierungsarbeiten muss durch qualifiziertes Personal erfolgen. Dieses muss in der Lage sein, das Gewicht, die Hebepunkte und die für die Sicherheit und Tragfähigkeit am besten geeigneten Hilfsmittel richtig einzuschätzen.

### 10.3 Empfang und Lagerung des Möbels

Überprüfen Sie den Zustand der Verpackung, bevor Sie das Gerät in Empfang nehmen.

Sollte die Verpackung sichtbare Beschädigungen aufweisen:

- Entfernen Sie die Verpackung unter den Augen des Lieferanten.
- Quittieren Sie den Empfang des Dokuments unter Vorbehalt.

Der Hersteller haftet nicht für Schäden, die durch den Transport oder die unsachgemäße Lagerung des Kühlmöbels entstehen.

Das Gerät muss an einem Ort gelagert werden, der vor Sonneneinstrahlung und Witterungseinflüssen geschützt ist und in dem eine Temperatur zwischen -25°C und +55°C sowie eine Luftfeuchtigkeit zwischen 30% und 95% herrschen.

Modello - Modèle - Model Modell - Modelo - Modelo	<b>PROFILE</b>	 eptarefrigeration
Fabbricante - Constructeur - Manufacturer Hersteller - Fabricante - Fabricante	<b>Epta Spa</b> - Via Mecenate, 86 - 20138 Milano (MI) ITALIA Tel. 02/55403211 Telefax 02/55401023	<b>27/32</b>

## 10.4 Installation und Umgebungsbedingungen

Das Gerät ist nicht für die Installation im Freien geeignet.

Für den korrekten Betrieb müssen bei der Positionierung des Geräts folgende Voraussetzungen erfüllt sein:

- Das Gerät muss auf einem ebenen Untergrund aufgestellt werden. ("Abb. 18").
- Es dürfen sich keine Wärmequellen, direkte Sonneneinstrahlung, Türen, Fenster, Ventilatoren oder Lüftungsöffnungen in der Nähe befinden ("Abb. 19").

Es muss genug Platz vorhanden sein, damit die Kundschaft das Gerät bedienen kann.

Die Hinweise zu den Umgebungsbedingungen, in denen das Gerät aufgestellt werden soll, finden Sie in: "Umgebungsbedingungen" (Tabelle "Tab. II", S."20").

## 10.5 Elektrischer Anschluss

Dem Gerät muss ein allpoliger Trennschalter vorgeschaltet werden. Dieser muss über eine ausreichende Trennstärke verfügen.

Der Kühltheke muss ein gut sichtbar für das Reinigungs- und Wartungspersonal angeordneter Leistungsschutzschalter vorgeschaltet sein, andernfalls muss sie mit einer in der getrennten Stellung verriegelbaren Ausschaltung ausgestattet sein.

Vergewissern Sie sich, dass die Netzspannung mit den Angaben auf dem Typenschild übereinstimmt, bevor Sie das Möbel an den Strom anschließen. Damit der ordnungsgemäße Betrieb gewährleistet ist, darf die Spannung insgesamt maximal zwischen +/- 6% vom Nennwert abweichen.

## 10.6 Technische Eigenschaften

Auf dem Typenschild werden alle spezifischen technischen Gerätedaten angegeben. Sie finden seine Position und die Art der Angaben in: "Technische Eigenschaften" ("Abb. 20").

Sie finden die Schaltpläne, Kalibrierungslisten der Kontrollinstrumente, Installationsanweisungen sowie eine Kopie der Konformitätserklärung unter dem folgenden Link: <https://documents.eptarefrigeration.com>. Der durch den Betrieb des Geräts erzeugte Schalldruckpegel liegt unter 70 dB(A). Das Möbel erzeugt keine schädlichen Schwingungen.

## 10.7 Die Befüllung des Kühlmöbels

Schalten Sie das Gerät über den an der Wand montierten Hauptschalter ein, um den Kühlkreislauf zu starten. Etwa 2 später können Sie damit beginnen, das Kühlmöbel zu befüllen.

Das Gerät ist dafür ausgelegt, die Temperatur der enthaltenen Waren aufrechtzuerhalten. Es ist nicht dazu ausgelegt, die Warentemperatur zu senken. Es sollten daher nur Waren in das Kühlmöbel gelegt werden, die bereits auf ihre jeweilige Lagertemperatur heruntergekühlt wurden. Sie sollten niemals Produkte im Kühlmöbel lagern, die sich zuvor erwärmt haben.

Wenn das Kühlmöbel über eine Frontverglasung verfügt, wird empfohlen, es außerhalb der Ladenöffnungszeiten zu befüllen.

Achten Sie beim Befüllen des Kühlmöbels darauf, dass:

- Das Kühlmöbel unter Berücksichtigung der Größe und Art der Waren gleichmäßig befüllt wird.
- Die Waren nicht die Zirkulation der Kaltluft beeinträchtigen ("Abb. 21")
- Die Waren nicht die Fülllinie überschreiten.
- Der obere Teil des Kühlmöbels darf nicht belastet werden ("Abb. 25").

Das zulässige Gesamtgewicht sich gleichmäßig im Kühlmöbel verteilt:

- Untere Ablagefläche: 225 kg/m<sup>2</sup>
- Auf den Etagern: 140 kg/m<sup>2</sup>
- Von den Regalen insgesamt: MAX 420 kg/m<sup>2</sup> (3 Regale) - 560 kg/m<sup>2</sup> (4 Regale)

Modello - Modèle - Model Modell - Modelo - Modelo	<b>PROFILE</b>	 epta refrigeration
Fabbricante - Constructeur - Manufacturer Hersteller - Fabricante - Fabricante	<b>Epta Spa</b> - Via Mecenate, 86 - 20138 Milano (MI) ITALIA Tel. 02/55403211 Telefax 02/55401023	<b>28/32</b>

## 10.8 Verwendung des Kühlmöbels



Für einen einwandfreien Betrieb, empfiehlt es sich außerdem prüfen, daß die Türen nicht offen bleiben.

### Beleuchtung

Der Schalter für die Beleuchtung des Kühlmöbels befindet sich unter rechts am Gerät.

### Thermostat/Thermometer

Auf der unter rechten Seite des Kühlmöbels befindet sich ein Fernthermostat/Thermometer zur Temperaturkontrolle ("Abb. 2", "Abb. 3", "Abb. 4").

Der Fernthermostat zeigt die Temperatur im Inneren der Theke an, diese lässt sich mit Hilfe der dazugehörigen Tasten kontrollieren.

### Anordnung und Neigung der Präsentationsregale

Um die korrekten Leistungen zu garantieren, für die das Möbel konzipiert wurde, müssen die Etagere im Möbel wie in der unten beschriebenen Konfiguration angeordnet werden (Tabelle "Tab. III" bis S. "25").

Stellungen geneigt werden, indem die Tragwinkel für die Fächer an den hinteren Ständern des Kühlmöbels entsprechend eingestellt werden. ("Abb. 24").

Nur für offenes Modell



Die Nachtdeckungen, falls vorhanden, während der Geschäftsschlusszeiten zu verwenden. ("Abb. 22").

Nur für geschlossenes Modell



Lassen Sie die oberen Glastüren niemals offen oder angelehnt. Es empfiehlt sich, regelmäßig zu überprüfen, dass alle Türen geschlossen sind: dadurch werden ein unnötiger Energieverlust und die Frostbildung an den Wänden vermieden und gleichzeitig wird eine optimalere Aufbewahrung der ausgestellten Lebensmittel garantiert.

## 10.9 Reinigung und regelmäßige Wartung

Es wird empfohlen, im Arbeitsbereich für gute Lichtverhältnisse zu sorgen und eventuell eine zusätzliche Leuchtquelle einzuschalten.

### Die Reinigung des Kühlmöbels

Verwenden Sie für die Reinigung nur Wasser mit einer Temperatur von max. 65°C sowie milde Haushaltsseife oder ein in Wasser verdünntes, neutrales Reinigungsmittel.

Verwenden Sie bei den Glasflächen ausschließlich Produkte, die für die Reinigung von Glasflächen geeignet sind. Von einer Reinigung mit Wasser wird abgeraten, da sich sonst Kalkablagerungen auf der Glasflächen bilden können.

Verwenden Sie auf keinen Fall:

- Scheuerschwämme
- Entzündliche Produkte oder aggressive Mittel wie Alkohol, Azeton oder Lösungsmittel
- Reinigungsmittel, die nichtionische Tenside, Zitrone oder Essig (Essigsäure) enthalten



Waschen oder reinigen Sie den oberen Teil des Kühlmöbels nicht mit Wasser oder anderen Flüssigkeiten.

Reinigen Sie alle Außenflächen des Kühlmöbels **EINMAL PRO WOCHE**.

Reinigen Sie alle Innenflächen des Kühlmöbels **EINMAL PRO MONAT** und befolgen Sie dafür die folgende Anleitung:

- Trennen Sie das Kühlmöbel mit Hilfe des Wandschalters vom Stromnetz ("Abb. 29").
- Entleeren Sie das Kühlmöbel und lagern Sie die Waren in Kühlzellen oder Kühlschränken, in denen die Konservierungstemperatur aufrechterhalten wird.
- Warten Sie ab, bis das Kühlmöbel die Umgebungstemperatur erreicht hat und fahren Sie mit der Reinigung folgendermaßen fort
- Stellen Sie sicher, dass der Innenraum des Kühlmöbels auch wirklich vollständig trocken ist und schließen Sie es dann wieder an die Stromversorgung an.
- Warten Sie ein paar Stunden ab, bevor Sie die Waren zurück in das Kühlmöbel legen.

Modello - Modèle - Model Modell - Modelo - Modelo	<b>PROFILE</b>	 epta refrigeration
Fabbricante - Constructeur - Manufacturer Hersteller - Fabricante - Fabricante	<b>Epta Spa</b> - Via Mecenate, 86 - 20138 Milano (MI) ITALIA Tel. 02/55403211 Telefax 02/55401023	<b>29/32</b>

Wenn Sie das Gerät außer Betrieb setzen, trennen Sie es von der Stromversorgung und verfahren wie oben beschrieben. Lassen Sie anschließend die Türen offen stehen (falls vorhanden), um zu vermeiden, dass sich unangenehme Gerüche bilden.

Sie sollten das Kühlmöbel **ALLE DREI MONATE** abtauen, damit Eiskristalle, die sich möglicherweise auf den Lamellen des Verdampfers gebildet haben, schmelzen und seine Funktion nicht beeinträchtigen. Die Dauer und die Anzahl der Abtauvorgänge sind bereits werkseitig eingestellt. Änderungen dürfen nur durch den technischen Wartungsdienst vorgenommen werden. Das Abtauwasser fließt durch einen speziellen Ablauf. Überprüfen Sie regelmäßig, dass das Abtauwasser normal abläuft. Sollte das nicht der Fall sein, verwenden Sie eine stumpfe, flexible Sonde.

Fahren Sie anschließend fort wie bei der **MONATLICHEN** Reinigung des Innenraums. Planen Sie aber eine entsprechend längere Wartezeit ein, da es dauern wird, bis das Eis komplett geschmolzen ist.

## 10.10 Gefahrensituationen

### Das Gerät geht nicht an oder stellt seinen Betrieb ein:

- Stellen Sie sicher, ob nicht vielleicht ein allgemeiner Stromausfall die Ursache ist.
- Überprüfen Sie, ob der Hauptschalter an der Wand eingeschaltet ist.
- Kontrollieren Sie, ob der Netzstecker richtig eingesteckt ist.

Wenn keiner der vorgenannten Gründe die Ursache für die Stromunterbrechung ist, wenden Sie sich sofort an das nächstgelegene autorisierte Service-Center. Räumen Sie das Kühlmöbel schnellstmöglich leer und lagern Sie die Waren in Kühlzellen und Kühlschränken, in denen die korrekte Konservierungstemperatur herrscht.

### Die Kühlleistung ist nicht ausreichend:

- Stellen Sie sicher dass das Kühlmöbel korrekt befüllt wurde.
- Falls in den letzten drei Monaten nicht geschehen, tauen Sie das Kühlmöbel ab und lassen Sie es anschließend seinen normalen Betrieb wiederaufnehmen.
- Überprüfen Sie, ob sich in der Nähe des Kühlmöbels eine Wärmequelle oder ein Luftzug befindet.
- Kontrollieren Sie die Umgebungsbedingungen, so wie sie im Abschnitt beschrieben sind: "Umgebungsbedingungen" ("Tab. II", S."20").
- Stellen Sie mit Hilfe einer Wasserwaage sicher, dass das Möbel gerade steht.

Sollte die Kühlleistung noch immer nicht ausreichend sein, wenden Sie sich an das nächste autorisierte Service-Center.

### Das Kühlmöbel ist laut:

- Stellen Sie sicher, dass alle Schrauben und Muttern fest angezogen sind.
- Stellen Sie mit Hilfe einer Wasserwaage sicher, dass das Möbel gerade steht.

Sollte der Lärm andauern, wenden Sie sich an das nächste autorisierte Service-Center.

## 10.11 Technischer Wartungsdienst

Sollten Sie technische Hilfe benötigen, wenden Sie sich bitte umgehend an den Lieferanten, bei dem Sie das Gerät gekauft haben. Sollten Sie Ersatzteile benötigen, wenden Sie sich immer an den technischen Kundendienst: Fragen Sie nach und vergewissern Sie sich, dass auch wirklich Originalersatzteile verwendet werden.

Modello - Modèle - Model Modell - Modelo - Modelo	<b>PROFILE</b>	 epta refrigeration
Fabbricante - Constructeur - Manufacturer Hersteller - Fabricante - Fabricante	<b>Epta Spa</b> - Via Mecenate, 86 - 20138 Milano (MI) ITALIA Tel. 02/55403211 Telefax 02/55401023	<b>30/32</b>

EN

## 10.12 Demontage und Entsorgung

IT

FR

DE

ES

PT

In Übereinstimmung mit den Entsorgungsvorschriften der einzelnen Länder und um unsere Umwelt zu schützen, bitten wir Sie, die einzelnen Komponenten des Geräts voneinander zu trennen, damit sie separat entsorgt oder ggf. ordnungsgemäß verwertet werden können.

Mit Ausnahme der Metallteile, die in den meisten europäischen Ländern nicht als Sondermüll eingestuft werden, sind die einzelnen Bauteile nicht wie Restmüll zu behandeln.



Das Kühlsystem arbeitet mit Hochdruck. Wenden Sie sich an qualifizierte Fachleute, bevor Sie das Gerät verschrotten.

Die zum Kühlkreislauf gehörigen Bauteile dürfen erst zerlegt und/oder abgetrennt werden, nachdem der Kühlkreislauf entleert wurde und das Kältegas durch qualifiziertes Personal aufgefangen wurde.

Modello - Modèle - Model Modell - Modelo - Modelo	<b>PROFILE</b>	 eptarefrigeration
Fabbricante - Constructeur - Manufacturer Hersteller - Fabricante - Fabricante	<b>Epta Spa</b> - Via Mecenate, 86 - 20138 Milano (MI) ITALIA Tel. 02/55403211 Telefax 02/55401023	<b>31/32</b>

## 11. ALLGEMEINE ERGÄNZENDE HINWEISE

### Hinweise zur korrekten Installation und Wartung

Alle Hinweise zur Installation und Wartung finden Sie im Benutzerhandbuch auf der folgenden Webseite:

[www.eptarefrigeration.com](http://www.eptarefrigeration.com).

Die Installationsanleitungen für qualifiziertes Fachpersonal sind in an folgender Stelle verfügbar:

- beim Kundenservice
- Im Lieferumfang einiger Produktkategorien ist die Installationsanleitung in Papierform enthalten

### Produktinformationen

Die Produktinformationen (EPREL) sind verfügbar, indem Sie die Website <https://eprel.eptarefrigeration.com>

### Gewährleistung

Für dieses Produkt besteht eine gesetzliche Gewährleistungsdauer von 12 Monaten, sofern nicht ausdrücklich etwas anderes vereinbart wurde.

### Professioneller Reparaturservice

Dieses Angebot wird von unseren Servicestellen für Sie bereitgestellt, Sie finden die Informationen unter dem folgenden Link: [www.eptarefrigeration.com](http://www.eptarefrigeration.com).

### Ersatzteile

Ersatzteile und Reparaturhinweise für das Gerät sind mindestens noch 8 Jahre, nachdem die Produktion eingestellt wurde, unter der folgenden Adresse verfügbar: [www.epta-service.com/service](http://www.epta-service.com/service).

Für die erforderlichen Zugangsdaten senden Sie bitte eine E-Mail an: [servicesupport@eptarefrigeration.com](mailto:servicesupport@eptarefrigeration.com).

### Wichtiger Hinweis zur Lebensmittelverschwendung

Es wird empfohlen, die Lagerungshinweise auf den Produktverpackungen und die Anweisungen der Lebensmittelhersteller sorgfältig zu beachten.

Die Temperatureinstellungen müssen dabei gemäß den Angaben in unserer technischen Dokumentation an die Konservierungseigenschaften der Lebensmittel angepasst werden.

Unsachgemäßer Gebrauch kann zum vorzeitigen Verderb von Lebensmitteln führen.

### Umgebungsbedingungen

Dieses Gerät ist für den Einsatz in einer Umgebung vorgesehen, in der die Temperatur und die Luftfeuchtigkeit innerhalb der in der Bedienungsanleitung angegebenen Bereiche liegen.

### Anweisungen zur Demontage

Die Demontage muss durch qualifizierte Fachkräfte erfolgen.

Die Epta-Gruppe legt seit jeher größten Wert auf den Schutz der Umwelt. Sie stellt daher allen Nutzern des Handbuchs die Anleitungen zur Demontage und Abfallbehandlung zum Herunterladen zur Verfügung.

- Greifen Sie auf die Website [www.bonnetneve.com](http://www.bonnetneve.com) zu



- Greifen Sie auf den Abschnitt **technischer Bereich** des Schanks zu.

Modello - Modèle - Model Modell - Modelo - Modelo	<b>PROFILE</b>	
Fabbricante - Constructeur - Manufacturer Hersteller - Fabricante - Fabricante	<b>Epta Spa</b> - Via Mecenate, 86 - 20138 Milano (MI) ITALIA Tel. 02/55403211 Telefax 02/55401023	<b>32/32</b>

## User Manual

EN

### Weitere Informationen

Bitte wenden Sie sich für nähere Informationen an die folgende Adresse [www.eptarefrigeration.com](http://www.eptarefrigeration.com) und an sie Produktdatenbank EPREL. Sie können diese Seite aufrufen, indem Sie den QR-Code auf dem Energielabel Ihres Geräts scannen.

IT

FR

DE

ES

PT



### Grenzen der vorgesehenen Anwendung



Dieses Gerät ist für den Einsatz, den Transport und die Lagerung bis zu einer maximalen Höhe von 2000 m über dem Meeresspiegel ausgelegt.

#### Lagerung:

- Temperatur zwischen 15°C und 50°C
- Relative Luftfeuchtigkeit zwischen 20% und 90%
- Maximal für 6 Monate

#### Transport:

- Temperatur zwischen 20°C und 70°C
- Relative Luftfeuchtigkeit zwischen 20% und 90%
- Maximal für 2 Monate

### Verwendung:

Die Klimanutzungsclass ist auf dem Typenschild angegeben.

Nachfolgend finden Sie einen Auszug aus dem Referenzstandard, der die Bedeutung der alphanumerischen Zeichen erläutert:

Klimaklasse	Trockenkugeltemp.	Relative Luftfeuchtigkeit
[-]	[°C]	[%]
0	20	50
1	16	80
8	24	55
2	22	65
3	25	60
4	30	55
6	27	70
5	40	40
7	35	75

BEISPIEL Klimaklasse 3 bedeutet 25°C / 60%R.H.

### Leistung



Die für den ordnungsgemäßen Betrieb des Geräts erforderlichen äußeren Umgebungsbedingungen sind auf dem Typenschild angegeben.

Die Leistung des Geräts kann bei einem anderen als dafür vorgesehenen Einsatz nicht gewährleistet werden.



Die Mindesttemperatur darf nicht unter 16°C liegen.

Modello - Modèle - Model Modell - Modelo - Modelo	<b>PROFILE</b>	 epta refrigeration
Fabbricante - Constructeur - Manufacturer Hersteller - Fabricante - Fabricante	<b>Epta Spa</b> - Via Mecenate, 86 - 20138 Milano (MI) ITALIA Tel. 02/55403211 Telefax 02/55401023	<b>4/32</b>

## User Manual

- EN
- IT
- FR
- DE
- ES**
- PT

## SÍMBOLOS UTILIZADOS



Símbolo de prohibición: se prohíbe realizar determinadas operaciones.



Símbolo de atención: normas de prevención de accidentes para el operador.



Símbolo de advertencia: posibilidad de dañar el mueble y/o sus componentes.



Símbolo de nota: proporciona información útil.

Modello - Modèle - Model Modell - Modelo - Modelo	<b>PROFILE</b>	 epta refrigeration
Fabbricante - Constructeur - Manufacturer Hersteller - Fabricante - Fabricante	<b>Epta Spa</b> - Via Mecenate, 86 - 20138 Milano (MI) ITALIA Tel. 02/55403211 Telefax 02/55401023	<b>5/32</b>

**ÍNDICE**

<b>1.</b>	<b>Introducción</b>	<b>6</b>	<b>EN</b>
<b>2.</b>	<b>Advertencias de seguridad</b>	<b>7</b>	<b>IT</b>
2.1	Advertencias generales	7	
2.2	Advertencias para el mantenimiento del mueble	9	<b>FR</b>
2.3	Advertencias eléctricas	9	
2.4	Prohibiciones	10	<b>DE</b>
<b>3.</b>	<b>Descripción general</b>	<b>11</b>	<b>ES</b>
3.1	Secciones	13	
<b>4.</b>	<b>Transporte del mueble</b>	<b>19</b>	<b>PT</b>
<b>5.</b>	<b>Condiciones ambientales</b>	<b>20</b>	
6.1	Referencia de modelos / denominación	21	
<b>6.</b>	<b>Características técnicas</b>	<b>21</b>	
<b>7.</b>	<b>Uso del mueble</b>	<b>22</b>	
<b>8.</b>	<b>Mantenimiento ordinario</b>	<b>24</b>	
8.1	Limpieza del mueble	24	
<b>9.</b>	<b>Configuración de estantes</b>	<b>25</b>	
<b>10.</b>	<b>Instrucciones para el usuario</b>	<b>26</b>	
10.1	Descripción del mueble	26	
10.2	Transporte y manipulación	26	
10.3	Recepción y almacenamiento	26	
10.4	Instalación y condiciones ambientales	27	
10.5	Conexión eléctrica	27	
10.6	Características técnicas	27	
10.7	Carga del producto	27	
10.8	Uso del mueble	28	
10.9	Limpieza y mantenimiento de rutina	28	
10.10	Situaciones de emergencia	29	
10.11	Asistencia técnica	29	
10.12	Desmantelamiento y eliminación	30	
<b>11.</b>	<b>Advertencias generales adicionales</b>	<b>31</b>	

Modello - Modèle - Model Modell - Modelo - Modelo	<b>PROFILE</b>	
Fabbricante - Constructeur - Manufacturer Hersteller - Fabricante - Fabricante	<b>Epta Spa</b> - Via Mecenate, 86 - 20138 Milano (MI) ITALIA Tel. 02/55403211 Telefax 02/55401023	<b>6/32</b>

## 1. INTRODUCCIÓN

Se recomienda leer atentamente el contenido de este manual y guardarlo junto con el mueble. El fabricante declina toda responsabilidad por los daños causados a las personas o a los bienes debido al incumplimiento de las advertencias contenidas en este manual.

Este manual de usuario se aplica a una familia de productos disponible en diferentes configuraciones y tamaños; el rendimiento y las especificaciones de cada modelo se complementan con la información proporcionada en la placa de características, la Declaración CE de Conformidad, así como con la etiqueta energética y la correspondiente ficha de información del producto EPREL.

El rendimiento de cada modelo individual puede variar en función de la configuración específica. La etiqueta energética y la ficha de información del producto también están disponibles en <https://eprel.eptarefrigeration.com> introduciendo el número de serie indicado en la placa de características.



Este manual contiene la información que se considera necesaria para el buen uso y funcionamiento del mueble.

Contiene las siguientes descripciones e información:

- una descripción funcional del mueble y de cada una de sus partes
- información sobre la seguridad del mueble y las normas de prevención de accidentes que se deben respetar
- uso correcto del mueble
- un correcto mantenimiento rutinario y programado, incluidas las operaciones de limpieza

Información no contenida en este manual:

- Instrucciones de instalación

Para la correcta instalación del mueble, consultar los siguientes documentos:

- Manual técnico
- Instrucciones de referencia rápida

Este manual está dirigido a los siguientes profesionales:

- **OPERADOR CUALIFICADO:** persona cualificada, capacitada en el funcionamiento, ajuste, limpieza y mantenimiento de rutina del mueble
- **TÉCNICO ESPECIALIZADO:** técnico capacitado y autorizado por el organismo indicado en el contrato (fabricante/concesionario/distribuidor) para realizar la instalación, el mantenimiento extraordinario, la reparación, la sustitución y la revisión del mueble

Las instrucciones de uso también están disponibles en:

[www.eptarefrigeration.com](http://www.eptarefrigeration.com).

**Consultar la declaración de conformidad para conocer las normas y certificaciones del mueble.**

**Conserve siempre el manual de instrucciones y en caso de venta.**

Modello - Modèle - Model Modell - Modelo - Modelo	<b>PROFILE</b>	 epta refrigeration
Fabbricante - Constructeur - Manufacturer Hersteller - Fabricante - Fabricante	<b>Epta Spa</b> - Via Mecenate, 86 - 20138 Milano (MI) ITALIA Tel. 02/55403211 Telefax 02/55401023	<b>7/32</b>

## 2. ADVERTENCIAS DE SEGURIDAD

### 2.1 Advertencias generales



La designación del aparato se indica en la página "21".



Este aparato está diseñado para funcionar en la clase ambiental 3 o 4; la definición de la clase ambiental se indica en la página "32".



El fabricante declina toda responsabilidad por los daños causados a las personas o a los bienes debido al incumplimiento de las advertencias contenidas en este manual. Toda persona que utilice el mueble debe leer este manual de uso.



Todas las operaciones de manipulación, transporte, montaje y desmontaje, durante la puesta fuera de servicio y durante la eliminación, deben ser realizadas exclusivamente por personal cualificado.



El empresario debe instruir al personal sobre los riesgos de accidentes, los dispositivos previstos para la seguridad del personal, los riesgos de emisión de ruidos y las normas generales de prevención de accidentes previstas por la normativa vigente.



El uso técnico del mostrador está restringido a personas autorizadas y formadas en las actividades; las actividades de uso técnico incluyen, por ejemplo, el encendido, los ajustes, la limpieza y el mantenimiento.



El uso del mueble para fines no técnicos, como por ejemplo la apertura de las puertas para retirar los productos expuestos, también puede ser realizado por niños de 8 años o más, o por personas con capacidades físicas, sensoriales o mentales reducidas, o sin experiencia y conocimientos, siempre que hayan sido debidamente supervisados o instruidos sobre el uso seguro del aparato y comprendan los riesgos asociados.

Los niños deben ser supervisados para que no jueguen con el aparato. La limpieza y el mantenimiento no deben ser realizados por niños sin supervisión.



Cualquier otro uso no indicado explícitamente en este manual debe considerarse peligroso y el fabricante no se hace responsable de los daños derivados de un uso inadecuado, incorrecto o no razonable.



El mueble debe ser utilizado por personal que dispone del equipo de protección personal adecuado.



Instruir a cualquier persona que utilice el mueble sobre la posición del interruptor seccionador.



El uso de guantes de trabajo es obligatorio.



El desmontaje de los resguardos o paneles que requieran el uso de herramientas para retirarlos está reservado exclusivamente al personal cualificado.

Modello - Modèle - Model Modell - Modelo - Modelo	<b>PROFILE</b>	 epta refrigeration
Fabbricante - Constructeur - Manufacturer Hersteller - Fabricante - Fabricante	<b>Epta Spa</b> - Via Mecenate, 86 - 20138 Milano (MI) ITALIA Tel. 02/55403211 Telefax 02/55401023	<b>8/32</b>

## User Manual

EN  
IT  
FR  
DE  
ES  
PT



Todos los trabajos deben ser realizados únicamente por personal cualificado y, en cualquier caso, se debe desconectar la alimentación eléctrica del mueble antes de realizar cualquier operación.



El ajuste del termostato se le reserva al personal técnico de asistencia.



Para la instalación de accesorios opcionales dedicados, contactar con el centro de asistencia autorizado más cercano.



No dejar el mueble expuesto a la intemperie.



No utilizar chorros de agua directos o indirectos sobre el mueble.



No tocar el mueble con las manos o los pies mojados o húmedos, no usarlo con los pies descalzos.



Prestar atención a las partes calientes o móviles marcadas con el símbolo correspondiente.



No dañar el circuito refrigerante.



Evitar la presencia de fuegos o chispas en el interior del aparato.



En caso de incendio, no utilizar agua para extinguir las llamas, sino sólo extintores de polvo seco.



No utilice aparatos eléctricos dentro de los compartimentos del aparato destinados a la conservación de alimentos frescos o congelados, salvo que sean del tipo recomendado por el fabricante.



No conservar en este mueble sustancias explosivas o peligrosas, como recipientes a presión con gas propelente inflamable.



No coloque recipientes para líquidos y no vierta líquidos sobre la encimera.



Dejar libres las aberturas de ventilación de la carcasa del aparato y no obstruirlas.



La información sobre la carga máxima de cada tipo de estante se proporciona en la página "27".





No apoyar objetos sobre la parte superior del mueble; es oportuno evitar que los productos no embalados se apoyen directamente sobre los estantes, sino que es preferible utilizar contenedores apropiados para alimentos.

Modello - Modèle - Model Modell - Modelo - Modelo	<b>PROFILE</b>	 epta refrigeration
Fabbricante - Constructeur - Manufacturer Hersteller - Fabricante - Fabricante	<b>Epta Spa</b> - Via Mecenate, 86 - 20138 Milano (MI) ITALIA Tel. 02/55403211 Telefax 02/55401023	<b>9/32</b>

## 2.2 Advertencias para el mantenimiento del mueble

 Las operaciones de mantenimiento deben ser realizadas únicamente por el personal autorizado.

 El acceso a las partes eléctricas y/o a las partes que requieren el uso de herramientas está reservado a los técnicos especializados.

 Antes de realizar cualquier operación de mantenimiento y limpieza reservada al usuario, desconectar la alimentación del mueble mediante el interruptor seccionador instalado en la pared.

 Prestar atención a las partes calientes o móviles marcadas con el símbolo correspondiente.

 El uso de guantes de trabajo es obligatorio.

 Es importante respetar el tipo y la frecuencia de las inspecciones y del mantenimiento necesarios para un funcionamiento seguro, incluidas las medidas de mantenimiento preventivo, tal como se describe en el párrafo "Limpieza y mantenimiento de rutina" en la página "28".

## 2.3 Advertencias eléctricas

 Asegurarse de que la tensión de alimentación coincida con los datos de la placa de características del mueble.

 La instalación eléctrica debe ser realizada por técnicos especializados.

 El desmontaje de la tapa del cuadro eléctrico está reservado a los técnicos especializados.

 De acuerdo con las normas de instalación, la red de alimentación debe incluir un dispositivo de desconexión omnipolar que garantice la desconexión completa de la red en condiciones de categoría de sobretensión III.

 La instalación del mueble debe realizarse siguiendo las instrucciones del fabricante, por personal profesionalmente cualificado y de conformidad con la normativa de instalación eléctrica vigente en cada país.

 Una instalación incorrecta del mueble puede causar daños a personas, animales o bienes, de los que el fabricante no se hace responsable.

 Si el cable de alimentación está dañado, debe ser sustituido por personal de servicio autorizado para evitar cualquier peligro. No intente reparar el cable.

 No encienda el mueble si está dañado. En caso de duda, póngase en contacto con el servicio posventa o con su distribuidor.

EN

IT

FR

DE

ES

PT

Modello - Modèle - Model Modell - Modelo - Modelo	<b>PROFILE</b>	 epta refrigeration
Fabbricante - Constructeur - Manufacturer Hersteller - Fabricante - Fabricante	<b>Epta Spa</b> - Via Mecenate, 86 - 20138 Milano (MI) ITALIA Tel. 02/55403211 Telefax 02/55401023	<b>10/32</b>

## 2.4 Prohibiciones

 Está prohibido utilizar dispositivos distintos a los suministrados en el mueble por el fabricante para acelerar el proceso de deshielo.

 Está prohibido que el personal no especializado retire la tapa del cuadro eléctrico o abra los paneles que requieran el uso de herramientas.

 Está prohibido utilizar el mueble para almacenar y/o exponer sustancias explosivas, inflamables o corrosivas, como aerosoles espray con gas propelente inflamable.

 Está prohibido utilizar el mueble para almacenar y/o exponer productos farmacéuticos.

 Está prohibido colocar el mueble en locales con presencia de sustancias gaseosas explosivas.

 Está prohibido quitar la placa de identificación del mueble.

 Está prohibido subirse al mostrador o al parachoques del mostrador.

 Queda prohibida la sustitución de componentes y/o la modificación del mostrador fuera de las especificaciones del fabricante, así como la sustitución de piezas de recambio originales por otras piezas no homologadas por el fabricante, se pena de perder las condiciones de la garantía.

Modello - Modèle - Model Modell - Modelo - Modelo	<b>PROFILE</b>	
Fabbricante - Constructeur - Manufacturer Hersteller - Fabricante - Fabricante	<b>Epta Spa</b> - Via Mecenate, 86 - 20138 Milano (MI) ITALIA Tel. 02/55403211 Telefax 02/55401023	<b>11/32</b>

### 3. DESCRIPCIÓN GENERAL

Abierto



1. Placa de datos
2. Iluminación superior
3. Cortinas de noche
4. Estantes
5. Vidrios laterales
6. Interruptor de luz
7. Teletermostato

Cerrado (Puertas de vidrio)



1. Placa de datos
2. Iluminación superior
3. Puertas en vidrio
4. Estantes
5. Vidrios laterales
6. Interruptor de luz
7. Teletermostato

EN

IT

FR

DE

ES

PT

Modello - Modèle - Model Modell - Modelo - Modelo	<b>PROFILE</b>	 epta refrigeration
Fabbricante - Constructeur - Manufacturer Hersteller - Fabricante - Fabricante	<b>Epta Spa</b> - Via Mecenate, 86 - 20138 Milano (MI) ITALIA Tel. 02/55403211 Telefax 02/55401023	<b>12/32</b>

## User Manual

### Cerrado (Puertas correderas de vidrio)



1. Placa de datos
2. Iluminación superior
3. Entregadas correderizas en vidrio
4. Estantes
5. Vidrios laterales
6. Interruptor de luz
7. Teletermostato

Modello - Modèle - Model Modell - Modelo - Modelo	<b>PROFILE</b>	
Fabbricante - Constructeur - Manufacturer Hersteller - Fabricante - Fabricante	<b>Epta Spa</b> - Via Mecenate, 86 - 20138 Milano (MI) ITALIA Tel. 02/55403211 Telefax 02/55401023	<b>13/32</b>

### 3.1 Secciones

#### H20Abierto

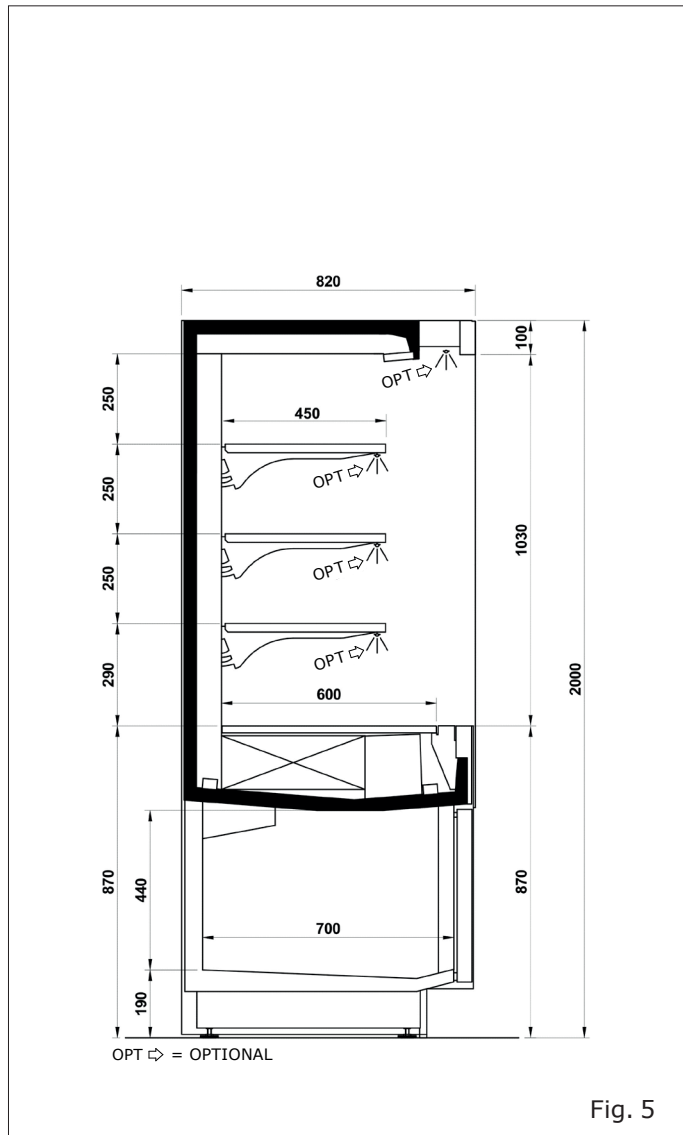

#### H20Abierto con ganchos

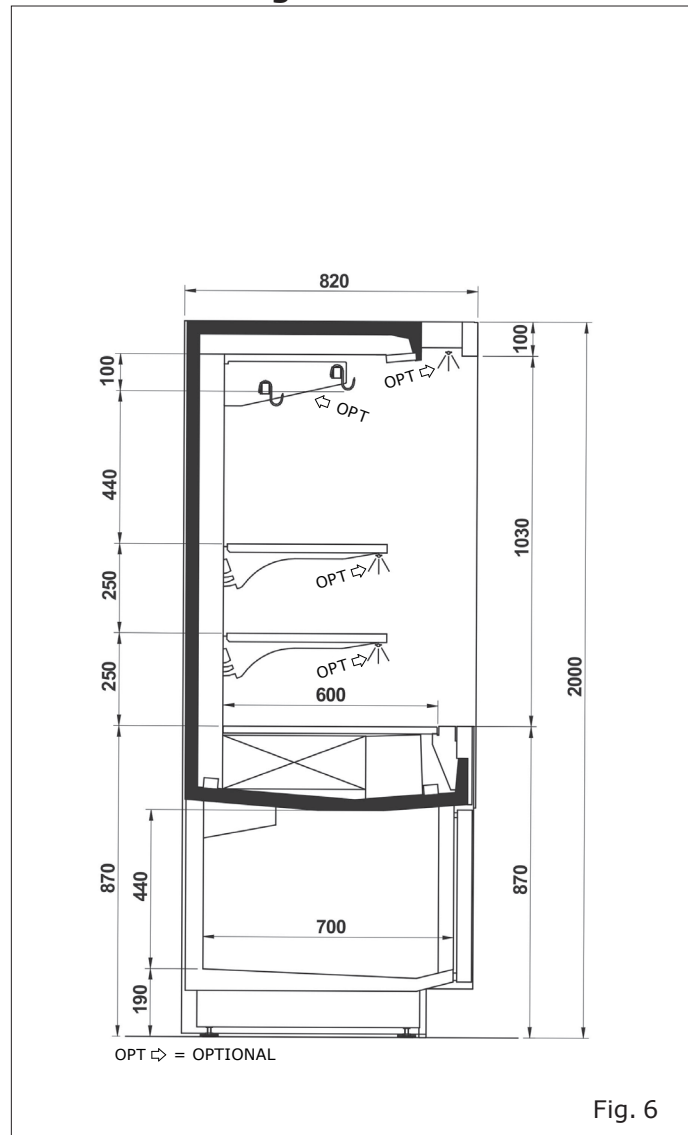

- EN
- IT
- FR
- DE
- ES**
- PT





Modello - Modèle - Model Modell - Modelo - Modelo	<b>PROFILE</b>	 epta refrigeration
Fabbricante - Constructeur - Manufacturer Hersteller - Fabricante - Fabricante	<b>Epta Spa</b> - Via Mecenate, 86 - 20138 Milano (MI) ITALIA Tel. 02/55403211 Telefax 02/55401023	<b>16/32</b>

User Manual

- EN
- IT
- FR
- DE
- ES
- PT

**H22Abierto con ganchos**

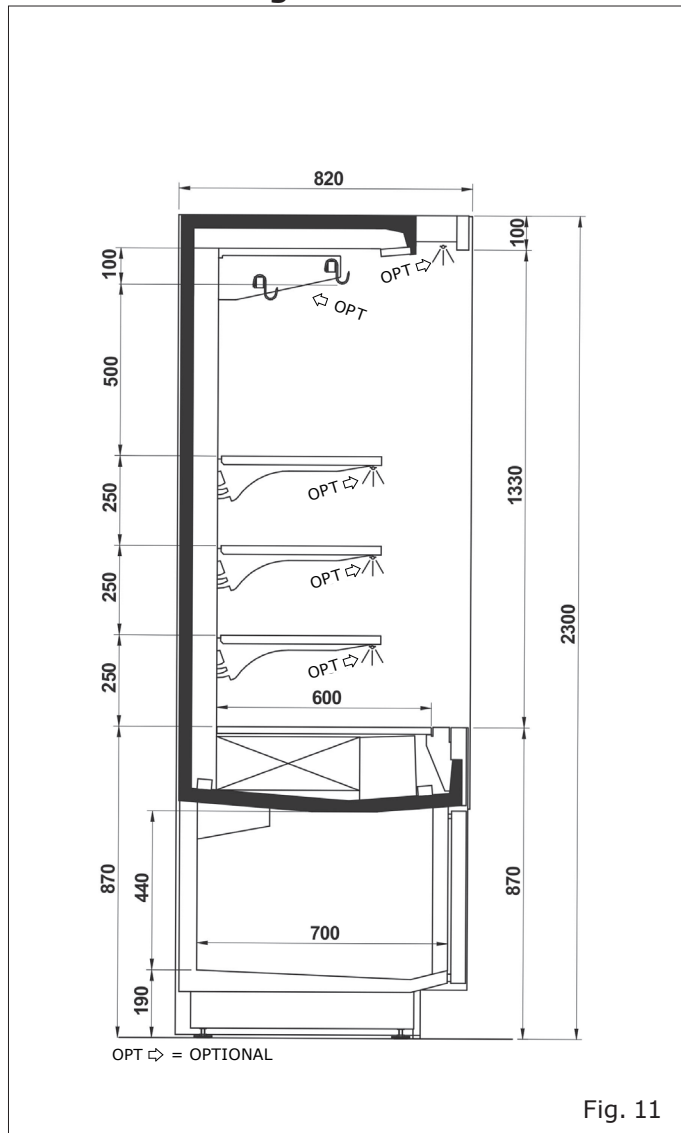

**H22Cerrado (Puertas de vidrio)**

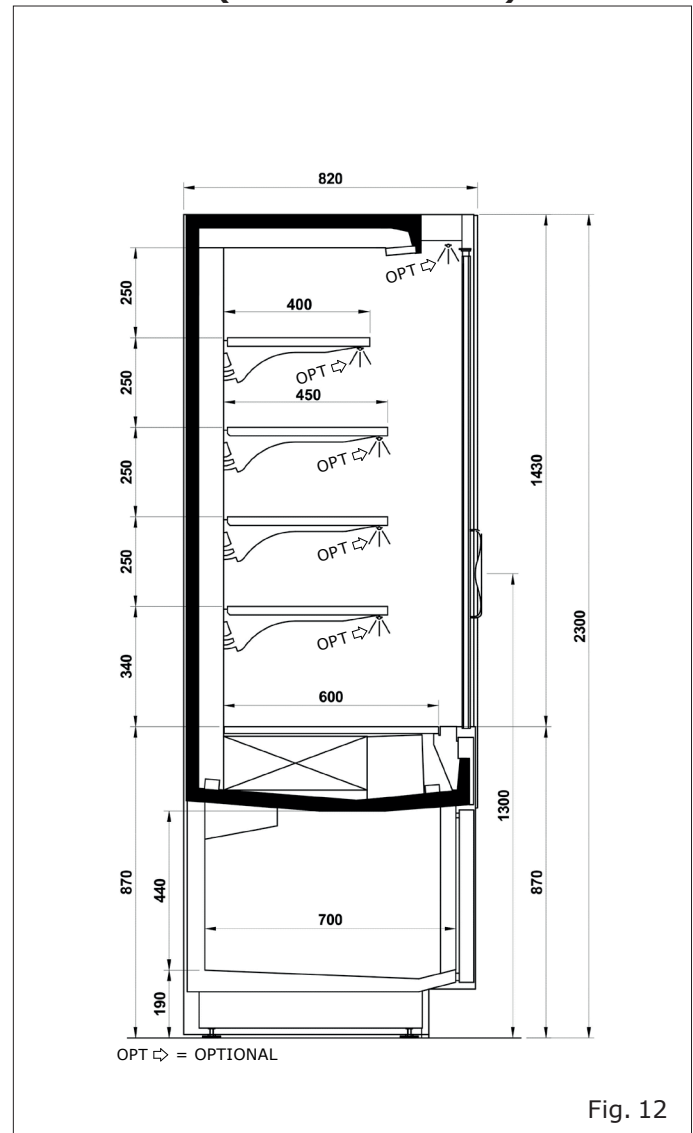

Modello - Modèle - Model Modell - Modelo - Modelo	<h1>PROFILE</h1>	
Fabbricante - Constructeur - Manufacturer Hersteller - Fabricante - Fabricante	<b>Epta Spa</b> - Via Mecenate, 86 - 20138 Milano (MI) ITALIA Tel. 02/55403211 Telefax 02/55401023	<b>17/32</b>

## H22Cerrado con ganchos (Puertas de vidrio)

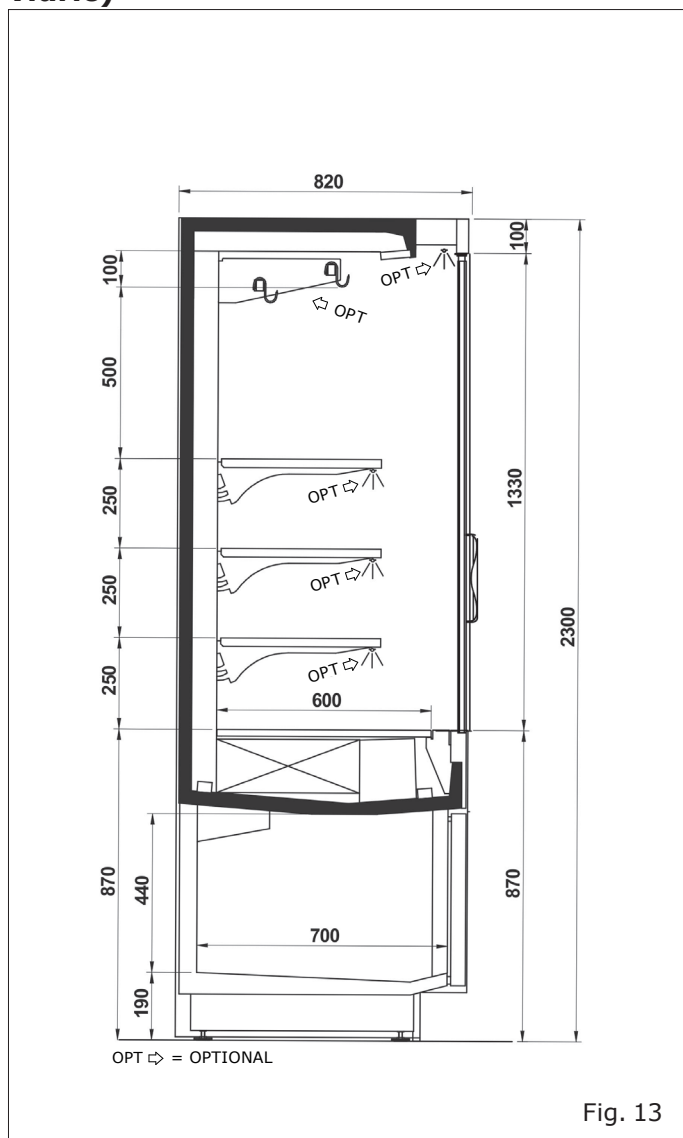

## H22Cerrado (Puertas correderas de vidrio)

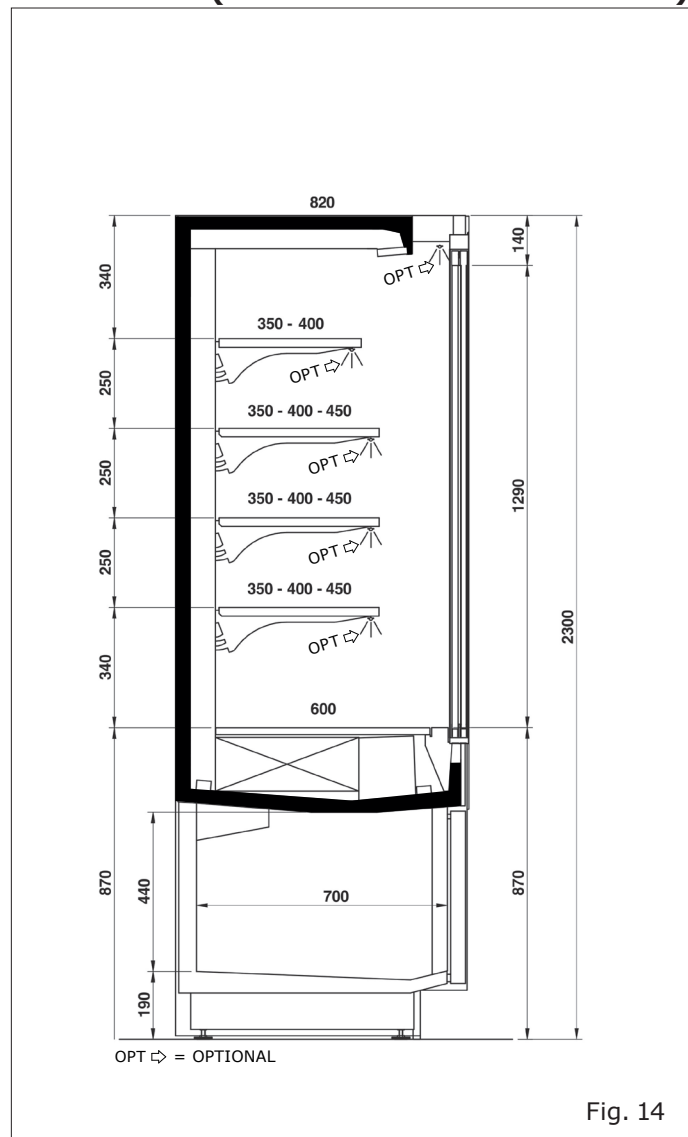

EN

IT

FR

DE

ES

PT



Modello - Modèle - Model Modell - Modelo - Modelo	<b>PROFILE</b>	 eptarefrigeration
Fabbricante - Constructeur - Manufacturer Hersteller - Fabricante - Fabricante	<b>Epta Spa</b> - Via Mecenate, 86 - 20138 Milano (MI) ITALIA Tel. 02/55403211 Telefax 02/55401023	<b>19/32</b>

## 4. TRANSPORTE DEL MUEBLE



1. Puntos de elevación

**Tabla I**

Altura	Longitud	Peso (kg)	Peso con embalaje (kg)
2000	1250	85	95
	1875	215	240
	2500	365	400
2300	1250	100	120
	1875	250	280
	2500	400	440
2500	1250	115	135
	1875	285	315
	2500	435	475

Modello - Modèle - Model Modell - Modelo - Modelo	<b>PROFILE</b>	 epta refrigeration
Fabbricante - Constructeur - Manufacturer Hersteller - Fabricante - Fabricante	<b>Epta Spa</b> - Via Mecenate, 86 - 20138 Milano (MI) ITALIA Tel. 02/55403211 Telefax 02/55401023	<b>20/32</b>

- EN
- IT
- FR
- DE
- ES
- PT

## 5. CONDICIONES AMBIENTALES



**Tabla II**

Características	
Tipo de local	Cerrado
Temperatura	25°C
Humedad relativa	60 %
Iluminación	600 lx



Modello - Modèle - Model Modell - Modelo - Modelo	<b>PROFILE</b>	 eptarefrigeration
Fabbricante - Constructeur - Manufacturer Hersteller - Fabricante - Fabricante	<b>Epta Spa</b> - Via Mecenate, 86 - 20138 Milano (MI) ITALIA Tel. 02/55403211 Telefax 02/55401023	<b>21/32</b>

## 6. CARACTERISTICAS TÉCNICAS









 <small>EPTA S.p.A. Via Mecenate, 86 20138 Milano - Italy</small>		 12	
1                      2		SN 13	 14
3                      4		REF 15	16
5                      6		REFRIGERANT KÄLTEMITTEL REFRIGÉRANT REFRIGERANTE REFRIGERANTE	17                      18 19                      20
7                      8		CLIMATIC CLASS KLIMAKLASSE CLASSE CLIMATIQUE CLASSE CLIMATICA CLASE CLIMÁTICA	
9		INSULATION BLOWING GAS ISOLATIONS GAS (BLÄHGAS) AGENT MOUSSANT D'ISOLATION GAS ESPANDENTE ISOLAMENTO AGENTE ESPUMANTE	
 10		PROTECTION INDEX SCHÜTZART INDEX DE LA PROTECTION INDICE DI PROTEZIONE ÍNDICE DE PROTECCIÓN	
 Read Operator's Manual available at <a href="http://www.eptarefrigeration.com">www.eptarefrigeration.com</a> or calling: +39 0437 968379		 11	24
			
			

Fig. 20

- |   |  |
|---|--|
| <ol style="list-style-type: none"> <li>1. Origen del producto</li> <li>2. Fabricado en «País de origen»</li> <li>3. Tensión nominal</li> <li>4. Potencia nominal</li> <li>5. Frecuencia nominal</li> <li>6. Corriente nominal</li> <li>7. Potencia de deshielo</li> <li>8. Corriente de deshielo</li> <li>9. Sistema de calentamiento</li> <li>10. Sistema de iluminación</li> <li>11. Manual del operador</li> <li>12. Código de barras</li> </ol> | <ol style="list-style-type: none"> <li>13. Número de serie</li> <li>14. Fecha de producción</li> <li>15. Código Hat</li> <li>16. Modelo/denominación</li> <li>17. Tipo de refrigerante 1</li> <li>18. Masa refrigerante 1</li> <li>19. Tipo de refrigerante 2</li> <li>20. Masa refrigerante 2</li> <li>21. Clase climática</li> <li>22. Aislamiento gas</li> <li>23. Índice de protección</li> <li>24. Marcas de certificación</li> </ol> |
|---|--|

### 6.1 Referencia de modelos / denominación

La tabla explica cómo leer el código de modelo, indicando la información comercial relevante para cada parte de la referencia (véase el campo de la etiqueta número: "16").

#### PROFILE xxx (Mueble refrigerado)

Referencia / denominación	Descripción	Información comercial
Profile	Nombre	Profile
xxx	Longitud	125(1250), 188(1875), 250(2500)

*ejemplo:*  
Profile125 = Profile 1250

Modello - Modèle - Model Modell - Modelo - Modelo	<b>PROFILE</b>	 epta refrigeration
Fabbricante - Constructeur - Manufacturer Hersteller - Fabricante - Fabricante	<b>Epta Spa</b> - Via Mecenate, 86 - 20138 Milano (MI) ITALIA Tel. 02/55403211 Telefax 02/55401023	<b>22/32</b>

EN  
IT  
FR  
DE  
ES  
PT

## 7. USO DEL MUEBLE



No cubrir

Solo para modelo abierto

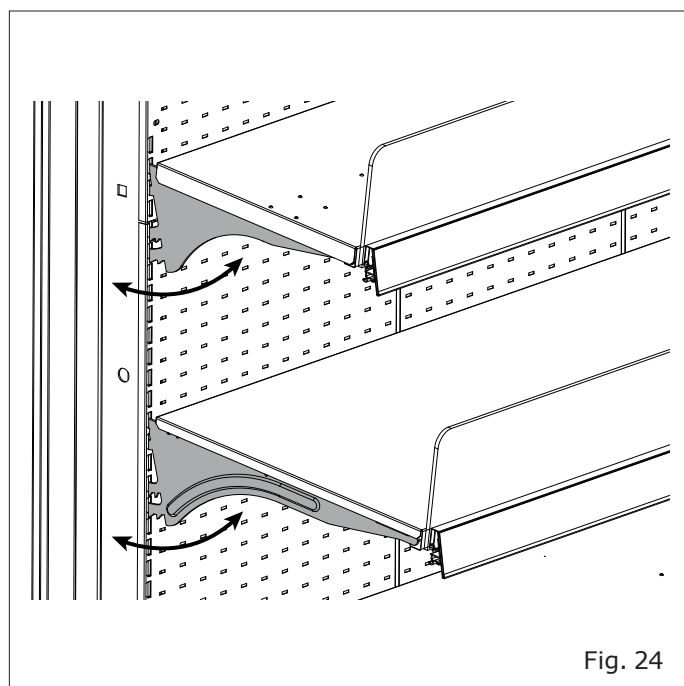

Inclinación de los estantes: 0° - 7° - 14° - 21°

Modello - Modèle - Model Modell - Modelo - Modelo	<h1>PROFILE</h1>	
Fabbricante - Constructeur - Manufacturer Hersteller - Fabricante - Fabricante	<b>Epta Spa</b> - Via Mecenate, 86 - 20138 Milano (MI) ITALIA Tel. 02/55403211 Telefax 02/55401023	<b>23/32</b>



- EN
- IT
- FR
- DE
- ES**
- PT

Modello - Modèle - Model Modell - Modelo - Modelo	<b>PROFILE</b>	 epta refrigeration
Fabbricante - Constructeur - Manufacturer Hersteller - Fabricante - Fabricante	<b>Epta Spa</b> - Via Mecenate, 86 - 20138 Milano (MI) ITALIA Tel. 02/55403211 Telefax 02/55401023	<b>24/32</b>

- EN
- IT
- FR
- DE
- ES
- PT

## 8. MANTENIMIENTO ORDINARIO

### 8.1 Limpieza del mueble

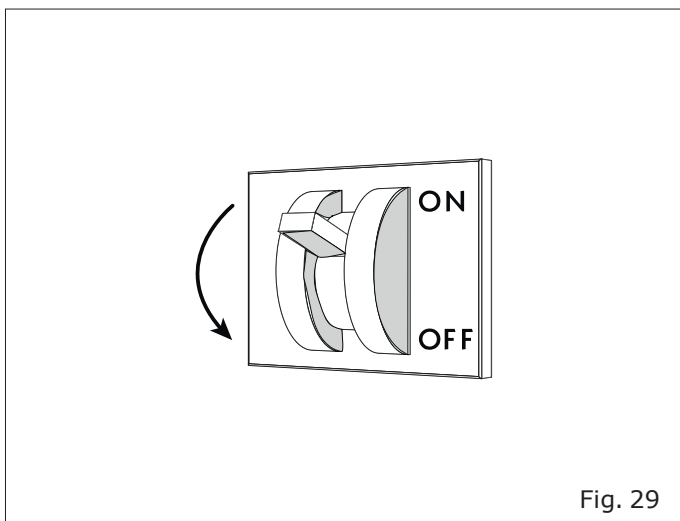

Modello - Modèle - Model Modell - Modelo - Modelo	<b>PROFILE</b>	 epta refrigeration
Fabbricante - Constructeur - Manufacturer Hersteller - Fabricante - Fabricante	<b>Epta Spa</b> - Via Mecenate, 86 - 20138 Milano (MI) ITALIA Tel. 02/55403211 Telefax 02/55401023	<b>25/32</b>

## 9. CONFIGURACIÓN DE ESTANTES

**Tabla III**

Configuración de estante de profundidad única			
Nivel	Con ganchos	Sin ganchos	H20
1	x	x	350-400-450 350-400-450
2	x	x	350-400-450 350-400-451
3	x	-	350-400-450 350-400-452

Configuración de estante de profundidad única			
Nivel	Con ganchos	Sin ganchos	H23
1	x	x	350-400-450 350-400-450
2	x	x	350-400-450 350-400-451
3	x	x	350-400-450 350-400-452
4	x	-	350-400-450 350-400-453

Modello - Modèle - Model Modell - Modelo - Modelo	<b>PROFILE</b>	
Fabbricante - Constructeur - Manufacturer Hersteller - Fabricante - Fabricante	<b>Epta Spa</b> - Via Mecenate, 86 - 20138 Milano (MI) ITALIA Tel. 02/55403211 Telefax 02/55401023	<b>26/32</b>

## 10. INSTRUCCIONES PARA EL USUARIO

### 10.1 Descripción del mueble

El mueble ha sido proyectado y producido exclusivamente para la exposición de alimentos frescos empaquetados, bebidas y productos lácteos.

**CLASE DE TEMPERATURA** (según EN ISO 23953-2):

- Abierto H20/H23: 3M1/3M2, H26: 3M2
- Cerrado H20/H23/H26: 3M1

Las características generales y las dimensiones se ilustran en las figuras y secciones contenidas en la "Descripción general" (de pág. "11" a pág. "18").

Los ajustes de temperatura recomendados para cada compartimento, para una conservación óptima de los alimentos, se indican en la ficha de información del producto disponible en EPREL o accediendo al sitio web <https://eprel.eptarefrigeration.com> y siguiendo las instrucciones proporcionadas para el acceso a la base de datos.

Durante las operaciones de transporte y manipulación, recepción y almacenamiento, instalación, carga, uso, limpieza y mantenimiento, y desmontaje, tener en cuenta el riesgo de vuelco del mueble ("Fig. 31").

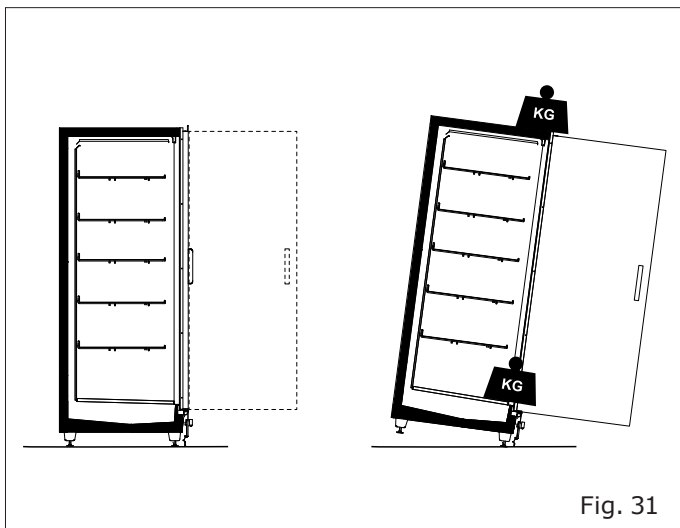

Fig. 31

### 10.2 Transporte y manipulación

El mueble está contenido en un embalaje especial equipado con una plataforma para su manipulación con carretillas elevadoras.

Para transportar y manipular el mueble utilizar:

- Sólo una plataforma adecuada o equivalente
- Una carretilla elevadora manual o eléctrica adecuada para la elevación del mueble, con las características apropiadas de acuerdo con las normas vigentes

El peso del mueble (vacío y con embalaje) y las dimensiones del embalaje se indican en "Transporte del mueble" (tabla "Tabla I" y las figuras en la página "19").

Las operaciones de manipulación deben ser realizadas por personal cualificado, capaz de evaluar los pesos, los puntos de elevación y los medios más adecuados, desde el punto de vista de la seguridad y la capacidad.

### 10.3 Recepción y almacenamiento

Comprobar el estado del embalaje antes de retirar el mueble del transportista.

Si hay daños evidentes en el embalaje:

- Retirar el embalaje del mueble en presencia del transportista.
- Firmar el documento de entrega con reserva.

El fabricante no se hace responsable de los daños causados por el transporte o del almacenamiento inadecuado del mueble.

El mueble debe almacenarse en un lugar protegido del sol y de la intemperie, con una temperatura entre  $-25^{\circ}\text{C}$  y  $+55^{\circ}\text{C}$  y una humedad relativa del aire comprendida entre 30% y 95%.

Modello - Modèle - Model Modell - Modelo - Modelo	<b>PROFILE</b>	 eptarefrigeration
Fabbricante - Constructeur - Manufacturer Hersteller - Fabricante - Fabricante	<b>Epta Spa</b> - Via Mecenate, 86 - 20138 Milano (MI) ITALIA Tel. 02/55403211 Telefax 02/55401023	<b>27/32</b>

## 10.4 Instalación y condiciones ambientales

El mueble no está diseñado para ser instalado en el exterior.

Para un buen funcionamiento del mueble, comprobar que esté colocado:

- Sobre un suelo nivelado ("Fig. 18").
- Lejos de fuentes de calor, luz solar directa, puertas, ventanas, ventiladores y rejillas de ventilación ("Fig. 19").

Asegurarse de que haya suficiente espacio para que los clientes utilicen el mueble.

Las condiciones del entorno en el que se va a colocar el mueble se indican en: "Condiciones ambientales" (tabla "Tabla II", Pag."20").

## 10.5 Conexión eléctrica

Debe instalarse un interruptor seccionador omnipolar antes del mueble. Debe tener poder de interrupción adecuado.

El interruptor seccionador debe estar situado aguas arriba del mostrador y debe ser visible para el operario durante las fases de limpieza y mantenimiento, o estar provisto de un seccionador de aislamiento.

Antes de conectar el mueble, asegurarse de que la tensión de alimentación sea la indicada en los datos de la placa de características del mueble. Para garantizar un funcionamiento óptimo, la variación máxima de la tensión debe estar comprendida entre +/- 6% del valor nominal.

## 10.6 Características técnicas

La placa de características muestra los datos técnicos distintivos del mueble. Su ubicación y el tipo de datos se indican en: "Características técnicas" ("Fig. 20").

Los diagramas eléctricos, las listas de calibración de los instrumentos de control, las instrucciones de instalación y una copia de la Declaración de Conformidad están disponibles en el sitio <https://documents.eptarefrigeration.com>.

El nivel de presión sonora generado por el funcionamiento del mueble es inferior a 70 dB(A). El mueble no provoca vibraciones perjudiciales.

## 10.7 Carga del producto

Dar tensión al mueble para iniciar su ciclo de enfriamiento, utilizando el interruptor seccionador general instalado en la pared. Después de unas 2 horas se puede cargar el mueble.

El mueble está diseñado para mantener la temperatura de la mercancía y no para bajarla; por lo tanto, los alimentos deben colocarse en el mueble solo si ya están enfriados a sus respectivas temperaturas de almacenamiento. Los productos que se han calentado nunca deben colocarse en el mueble.

Si el mueble tiene vidrios en la parte delantera, es aconsejable cargar la mercancía cuando no haya clientes en el espacio de venta.

Al cargar las mercancías, asegurarse de que:

- La carga sea homogénea en cuanto a tamaño y calidad de las mercancías.
- La mercancía no obstruya el correcto flujo de aire refrigerado ("Fig. 21")
- La mercancía no sobrepase la línea de carga.
- La parte superior del mueble no debe cargarse ("Fig. 25").

La carga máxima admisible esté distribuida uniformemente:

- En el plano de fondo: 225 kg/m<sup>2</sup>
- En los estantes: 140 kg/m<sup>2</sup>
- Del total de estantes: MAX 420 kg/m<sup>2</sup> (3 estantes) - 560 kg/m<sup>2</sup> (4 estantes)

Modello - Modèle - Model Modell - Modelo - Modelo	<b>PROFILE</b>	 epta refrigeration
Fabbricante - Constructeur - Manufacturer Hersteller - Fabricante - Fabricante	<b>Epta Spa</b> - Via Mecenate, 86 - 20138 Milano (MI) ITALIA Tel. 02/55403211 Telefax 02/55401023	<b>28/32</b>

## 10.8 Uso del mueble



Para un mejor funcionamiento del mostrador se recomienda que las puertas no queden abiertas.

### Iluminación

La iluminación del mueble es accionada por un interruptor situado en la parte abajo derecha del mueble.

### Termostato/termómetro

En la parte abajo derecha del mueble hay un termostato/termómetro remoto para controlar la temperatura ("Fig. 2", "Fig. 3", "Fig. 4"). El termostato remoto muestra la temperatura en el interior de la carcasa y permite controlar la temperatura mediante los botones previstos.

### Configuración e inclinación de los estantes de exhibición.

Para garantizar las prestaciones correctas para las cuales el mueble ha sido proyectado, la disposición de los estantes dentro del mueble debe respetar la configuración que abajo se describe (tabla "Tabla III" a pág. "25"). Se pueden inclinar en 4 diferentes ángulos, simple mente cambiando la posición de enganche de los soportes de los estantes con los montantes traseros del mueble. ("Fig. 24").

Solo para modelo abierto



Usar las tapas o las cortinas de noche, de haberlas, durante las horas en que no se atiende al público. ("Fig. 22").

Solo para modelo cerrado



Nunca dejar las puertas de vidrio abiertas o entreabiertas. Se aconseja verificar a menudo que todas las puertas estén cerradas: se evitarán así tanto inútiles consumos de energía como la formación innecesaria de escarcha sobre las paredes, y al mismo tiempo se obtendrá una mejor conservación de los productos expuestos.

## 10.9 Limpieza y mantenimiento de rutina

Se recomienda mantener una buena visibilidad en la zona de intervención, usando una fuente de iluminación adicional si fuera necesario.

### Limpieza del mueble

Utilizar únicamente agua a una temperatura máxima de 65°C y jabón o detergente doméstico neutro diluido en agua.

Para superficies acristaladas utilizar sólo productos de limpieza de vidrios. Se recomienda evitar el uso de agua, ya que puede depositar sedimentos calcáreos sobre la superficie del vidrio.

Por ningún motivo usar:

- Esponjas abrasivas
- Productos inflamables o abrasivos como alcohol, acetona o disolventes
- Detergentes con tensioactivos no iónicos, limón o vinagre (ácido acético)



No lavar ni limpiar la parte superior del mueble con agua o líquidos.

Limpiar **UNA VEZ POR SEMANA** todas las partes externas del mueble.

Limpiar **UNA VEZ POR MES** todas las partes internas del mueble, siguiendo las instrucciones siguientes:

- Desconectar la alimentación eléctrica del mueble mediante el interruptor seccionador general instalado en la pared ("Fig. 29").
- Vaciar el mueble, almacenando la mercancía en cámaras o refrigeradores adecuados para mantener la temperatura de almacenamiento.
- Esperar a que el interior del mueble haya alcanzado la temperatura ambiente y proceder a la limpieza
- Después de comprobar cuidadosamente que el interior del mueble esté completamente seco, ponerlo en función otra vez volviéndolo a conectar.
- Después de un par de horas cargar la mercancía de nuevo.

Modello - Modèle - Model Modell - Modelo - Modelo	<b>PROFILE</b>	 epta refrigeration
Fabbricante - Constructeur - Manufacturer Hersteller - Fabricante - Fabricante	<b>Epta Spa</b> - Via Mecenate, 86 - 20138 Milano (MI) ITALIA Tel. 02/55403211 Telefax 02/55401023	<b>29/32</b>

Cuando se pone el mueble fuera de servicio, desconectar la alimentación y realizar las operaciones anteriores, dejando las puertas abiertas (Si alguna) para evitar olores desagradables.

**CADA TRES MESES** descongelar el mueble para permitir que se derrita el hielo que pueda haberse formado en las aletas del evaporador, impidiendo su correcto funcionamiento. La duración y el número de deshielos se regulan directamente en fábrica. Cualquier ajuste está reservado exclusivamente al servicio técnico de asistencia. El agua de deshielo es recogida por un desagüe especial. Comprobar periódicamente que el agua de deshielo fluya con normalidad. Si así no fuera, utilizar una sonda flexible no puntiaguda.

Proceder como se indica para la limpieza **MENSUAL** de las partes internas, pero en este caso debe prever un tiempo de espera mayor para que el hielo se derrita completamente.

### 10.10 Situaciones de emergencia

#### El mueble no arranca o se detiene:

- Comprobar que no haya una situación de apagón eléctrico.
- Controlar que el interruptor general de pared esté encendido.
- Controlar que el enchufe del mueble esté conectado a la toma de corriente.

Si el fallo de la alimentación eléctrica no depende de estos motivos, contactar con el centro de asistencia autorizado más cercano, vaciar completamente el mueble sacando los productos y almacenarlos de inmediato en las cámaras o refrigeradores idóneos a mantener la temperatura de conservación.

#### El mueble no enfría lo suficiente:

- Controlar que la carga del mueble sea correcta.
- Descongelar el mueble y reanudar el funcionamiento normal, si se han superado los tres meses de la última operación.
- Controlar que el mueble no esté colocado cerca de fuentes de calor o corrientes de aire.
- Comprobar las condiciones ambientales indicadas en "Condiciones ambientales" ("Tabla II", Pag."20").
- Utilizar un nivel de burbuja para comprobar la planaridad del mueble.

Si la falta de refrigeración persiste, contactar con el centro de asistencia autorizado más cercano.

#### El mueble es ruidoso:

- Controlar que los tornillos y pernos estén perfectamente apretados.
- Utilizar un nivel de burbuja para comprobar la planaridad del mueble.

Si el problema persiste, contactar con el centro de asistencia autorizado más cercano.

### 10.11 Asistencia técnica

Si fuera necesaria la intervención del personal de asistencia técnica, contactar inmediatamente con el proveedor al que compró el mueble. Si es necesario utilizar piezas de recambio, dirigirse siempre al servicio técnico de asistencia: solicitar y comprobar que se utilicen piezas de recambio originales.

EN

IT

FR

DE

ES

PT

Modello - Modèle - Model Modell - Modelo - Modelo	<b>PROFILE</b>	 epta refrigeration
Fabbricante - Constructeur - Manufacturer Hersteller - Fabricante - Fabricante	<b>Epta Spa</b> - Via Mecenate, 86 - 20138 Milano (MI) ITALIA Tel. 02/55403211 Telefax 02/55401023	<b>30/32</b>

## 10.12 Desmantelamiento y eliminación

De acuerdo con las normas de eliminación de los residuos vigentes en cada país y por respeto al medio ambiente en el que vivimos, es importante separar las piezas del mueble para que puedan ser eliminadas por separado o, en su caso, recuperadas adecuadamente.

Todas las partes que componen el mueble no pueden tratarse como residuos urbanos, excepto las partes metálicas, que no están clasificadas como residuos especiales en la mayoría de los países europeos.



El sistema de refrigeración es de alta presión. Contactar con personal experto antes del desguace.

Los componentes del circuito de refrigeración no deben cortarse y/o separarse antes de vaciar el circuito. El personal cualificado debe recuperar el gas refrigerante.

Modello - Modèle - Model Modell - Modelo - Modelo	<b>PROFILE</b>	
Fabbricante - Constructeur - Manufacturer Hersteller - Fabricante - Fabricante	<b>Epta Spa</b> - Via Mecenate, 86 - 20138 Milano (MI) ITALIA Tel. 02/55403211 Telefax 02/55401023	<b>31/32</b>

## 11. ADVERTENCIAS GENERALES ADICIONALES

### Instrucciones para una correcta instalación y mantenimiento

Las instrucciones de uso y mantenimiento se describen en el Manual del Usuario disponible en el sitio:

[www.eptarefrigeration.com](http://www.eptarefrigeration.com).

Las instrucciones de instalación dedicadas al personal experto están disponibles:

- En la red de asistencia
- En algunas categorías de producto, impresas en papel y entregadas con el producto

### Información del producto

La información del producto (EPREL) está disponible accediendo al sitio web <https://eprel.eptarefrigeration.com> y siguiendo las instrucciones indicadas para acceder a la base de datos.

### Garantía

De acuerdo con la ley, el producto está garantizado durante un período de 12 meses, a menos que las partes acuerden explícitamente lo contrario.

### Servicios profesionales de reparación

Los servicios son prestados por nuestra red de asistencia que puede ser consultada en el área de contactos en la dirección web [www.eptarefrigeration.com](http://www.eptarefrigeration.com).

### Piezas de recambio

Las piezas de recambio y la información sobre las reparaciones de los aparatos están disponibles durante al menos 8 años después de que el producto haya sido descatalogado en la siguiente dirección web: [www.epta-service.com/service](http://www.epta-service.com/service).

Las credenciales de acceso se facilitan previa solicitud que se enviará por correo electrónico a: [servicesupport@eptarefrigeration.com](mailto:servicesupport@eptarefrigeration.com).

### Información importante sobre el desperdicio de alimentos

Se recomienda respetar atentamente las instrucciones de almacenamiento descritas en los envases de los productos y las instrucciones proporcionadas por los fabricantes de alimentos.

Por lo tanto, las configuraciones de temperatura deben adaptarse a las características de conservación de los productos alimenticios de acuerdo con las indicaciones que figuran en nuestra documentación técnica.

Un uso inadecuado puede provocar su deterioro.

### Condiciones ambientales

Este aparato está destinado a ser utilizado en entornos en los que la temperatura y la humedad respetan los límites especificados en el Manual de uso y mantenimiento.

### Instrucciones de desmontaje

Para el desmontaje es necesario dirigirse a operadores profesionales.

El grupo Epta, que siempre ha prestado una especial atención al medio ambiente, pone a disposición de los usuarios los manuales de desmantelamiento y tratamiento de residuos que pueden descargarse a continuación.

- Acceder al sitio [www.bonnetneve.com](http://www.bonnetneve.com)

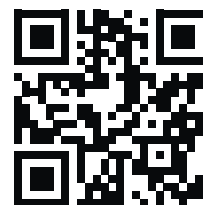

- Acceda a la sección **área técnica** del gabinete.

Modello - Modèle - Model Modell - Modelo - Modelo	<b>PROFILE</b>	 eptarefrigeration
Fabbricante - Constructeur - Manufacturer Hersteller - Fabricante - Fabricante	<b>Epta Spa</b> - Via Mecenate, 86 - 20138 Milano (MI) ITALIA Tel. 02/55403211 Telefax 02/55401023	<b>32/32</b>

## User Manual

EN  
IT  
FR  
DE  
ES  
PT

### Más información

Para obtener información más detallada, consultar [www.eptarefrigeration.com](http://www.eptarefrigeration.com) y EPREL, a los que puede acceder mediante el código QR aquí o en la etiqueta energética del producto.



### Límites de aplicación



Este mueble está diseñado para su uso, transporte y almacenamiento hasta una altitud máxima de 2000 m sobre el nivel del mar.

#### Almacenamiento:

- Temperatura entre 15°C y 50°C
- Humedad relativa entre 20% y 90%
- Tiempo máximo 6 meses

#### Transporte:

- Temperatura entre 20°C y 70°C
- Humedad relativa entre 20% y 90%
- Tiempo máximo 2 meses

### Uso

La clase climática de utilización se muestra en la placa de características.

A continuación se muestra un extracto de la norma de referencia, que aclara el significado de los caracteres alfanuméricos:

Clase climática	Temperatura de bulbo seco	Humedad relativa
[-]	[°C]	[%]
0	20	50
1	16	80
8	24	55
2	22	65
3	25	60
4	30	55
6	27	70
5	40	40
7	35	75

EJEMPLO La clase climática 3 significa 25°C / 60%R.H.

### Prestaciones



Las condiciones ambientales externas necesarias para el correcto funcionamiento del mueble están indicadas en la placa de características.

Las prestaciones del mueble no están garantizadas fuera de su uso normal.



La temperatura mínima no debe ser inferior a 16°C.

Modello - Modèle - Model Modell - Modelo - Modelo	<b>PROFILE</b>	 epta refrigeration
Fabbricante - Constructeur - Manufacturer Hersteller - Fabricante - Fabricante	<b>Epta Spa</b> - Via Mecenate, 86 - 20138 Milano (MI) ITALIA Tel. 02/55403211 Telefax 02/55401023	<b>4/32</b>

- EN
- IT
- FR
- DE
- ES
- PT**

## SIMBOLOGIA UTILIZADA



Símbolo proibição: proíbe efetuar determinadas operações.



Símbolo atenção: normas contra acidentes para o operador.



Símbolo advertências: existe a possibilidade de danificar o balcão e/ou os seus componentes.



Símbolo nota: fornece informações úteis.

Modello - Modèle - Model Modell - Modelo - Modelo	<b>PROFILE</b>	 epta refrigeration
Fabbricante - Constructeur - Manufacturer Hersteller - Fabricante - Fabricante	<b>Epta Spa</b> - Via Mecenate, 86 - 20138 Milano (MI) ITALIA Tel. 02/55403211 Telefax 02/55401023	<b>5/32</b>

**ÍNDICE**

<b>1. Introdução</b>	<b>6</b>	<b>EN</b>
<b>2. Advertências de segurança</b>	<b>7</b>	<b>IT</b>
2.1 Advertências gerais	7	
2.2 Advertências para a Manutenção do balcão	9	<b>FR</b>
2.3 Advertências elétricas	9	
2.4 Proibições	10	<b>DE</b>
<b>3. Descrição geral</b>	<b>11</b>	<b>ES</b>
3.1 Seções	13	
<b>4. Transporte do balcão</b>	<b>19</b>	<b>PT</b>
<b>5. Condições ambientais</b>	<b>20</b>	
6.1 Referência dos modelos / designação	21	
<b>6. Características técnicas</b>	<b>21</b>	
<b>7. Utilização do balcão</b>	<b>22</b>	
<b>8. Manutenção ordinária</b>	<b>24</b>	
8.1 Limpeza do balcão	24	
<b>9. Configuração de prateleiras</b>	<b>25</b>	
<b>10. Indicações para o utilizador</b>	<b>26</b>	
10.1 Descrição do balcão	26	
10.2 Transporte e movimentação	26	
10.3 Receção e armazenagem	26	
10.4 Instalação e condições ambientais	27	
10.5 Ligação elétrica	27	
10.6 Características técnicas	27	
10.7 Carregamento do produto	27	
10.8 Utilização do balcão	28	
10.9 Limpeza e manutenção ordinária	28	
10.10 Situações de emergência	29	
10.11 Assistência técnica	29	
10.12 Desmantelamento e eliminação	30	
<b>11. Advertências gerais adicionais</b>	<b>31</b>	

Modello - Modèle - Model Modell - Modelo - Modelo	<b>PROFILE</b>	 epta-refrigeration
Fabbricante - Constructeur - Manufacturer Hersteller - Fabricante - Fabricante	<b>Epta Spa</b> - Via Mecenate, 86 - 20138 Milano (MI) ITALIA Tel. 02/55403211 Telefax 02/55401023	<b>6/32</b>

## 1. INTRODUÇÃO

Recomenda-se ler com atenção o conteúdo do presente Manual e conservá-lo junto com o balcão.

O fabricante não pode ser responsabilizado por danos causados a pessoas ou coisas devido à falta de observância das advertências contidas neste Manual.

Este manual do utilizador aplica-se a uma família de produtos disponível em diferentes configurações e dimensões; o desempenho e as especificações de cada modelo são complementados pelas informações fornecidas na placa de características, na Declaração CE de Conformidade, bem como pela etiqueta energética e pela respetiva ficha de informação do produto EPREL.

O desempenho de cada modelo individual pode variar consoante a configuração específica. A etiqueta energética e a ficha de informação do produto estão igualmente disponíveis em <https://eprel.eptarefrigeration.com>, mediante a introdução do número de série indicado na placa de características.



Fig. N

O presente Manual contém informações consideradas necessárias para a boa utilização e funcionamento do balcão.

No seu interior estão presentes as seguintes descrições e informações:

- uma descrição das funções do balcão e de todas as suas partes
- informações relativas à segurança do balcão e as regras contra acidentes a observar
- uma utilização correta do balcão
- uma correta manutenção ordinária e programada, incluindo as operações de limpeza

informações não contidas no presente Manual:

- Instruções relativas à instalação

Para a instalação correta do balcão remeter-se aos seguintes documentos:

- Manual Técnico
- Instruções de consulta rápida

O presente manual destina-se às seguintes figuras profissionais:

- **OPERADOR QUALIFICADO**, pessoa qualificada, formada para o funcionamento, a regulação, a limpeza e a manutenção ordinária do móvel
- **TÉCNICO ESPECIALIZADO** técnico treinado e autorizado pelo organismo indicado no contrato (fabricante/concessionário/distribuidor) a realizar a instalação, manutenção extraordinária, reparação, substituição e revisão do balcão

As instruções de uso também estão disponíveis em:

[www.eptarefrigeration.com](http://www.eptarefrigeration.com).

**Remeter-se à declaração de conformidade para os regulamentos e as certificações do balcão.**

**Guarde sempre o folheto de instruções e em caso de venda.**

Modello - Modèle - Model Modell - Modelo - Modelo	<b>PROFILE</b>	 epta refrigeration
Fabbricante - Constructeur - Manufacturer Hersteller - Fabricante - Fabricante	<b>Epta Spa</b> - Via Mecenate, 86 - 20138 Milano (MI) ITALIA Tel. 02/55403211 Telefax 02/55401023	<b>7/32</b>

## 2. ADVERTÊNCIAS DE SEGURANÇA

### 2.1 Advertências gerais



A designação do aparelho é indicada na página "21".



Este aparelho foi concebido para funcionar na classe ambiental 3 ou 4; a definição da classe ambiental é fornecida na página "32".



O fabricante não pode ser responsabilizado danos causados a pessoas ou a coisas devido à falta de observância das advertências contidas neste manual. Qualquer pessoa que utilizar este balcão deverá ler o presente manual de utilização.



Todas as operações de movimentação, transporte, montagem e desmontagem, durante a colocação fora de serviço e durante a eliminação, devem ser realizadas exclusivamente por pessoal qualificado.



O empregador terá de formar o pessoal relativamente aos riscos decorrentes de acidentes, sobre os dispositivos preparados para a segurança do pessoal, riscos de emissão de ruído e regras gerais contra acidentes previstas pelas normas em vigor.



A utilização técnica do balcão está reservada a pessoas autorizadas e devidamente formadas; as actividades de utilização técnica incluem, por exemplo, a ligação, as regulações, a limpeza e a manutenção.



A utilização do móvel para fins não técnicos, como por exemplo a abertura das portas para retirar os produtos expostos, pode também ser efetuada por crianças com idade igual ou superior a 8 anos, ou por pessoas com capacidades físicas, sensoriais ou mentais reduzidas, ou sem experiência e conhecimento, desde que tenham sido devidamente supervisionadas ou instruídas quanto à utilização segura do aparelho e compreendam os perigos envolvidos.

As crianças devem ser supervisionadas para garantir que não brincam com o aparelho.

A limpeza e a manutenção não devem ser realizadas por crianças sem supervisão.



Qualquer outra utilização não explicitamente indicada neste manual é de considerar perigosa, não podendo o fabricante se responsabilizar por eventuais danos decorrentes de utilização indevida, errada e não razoável.



O balcão tem de ser utilizado por pessoal dotado de adequados dispositivos de proteção individuais.



Formar quem utilizar o balcão sobre a posição do interruptor seccionador.



É obrigatório utilizar luvas de trabalho.



A remoção de proteções ou de painéis que exigem a utilização de ferramenta para ser removidos é reservada exclusivamente ao pessoal qualificado.

EN

IT

FR

DE

ES

PT

Modello - Modèle - Model Modell - Modelo - Modelo	<b>PROFILE</b>	 epta refrigeration
Fabbricante - Constructeur - Manufacturer Hersteller - Fabricante - Fabricante	<b>Epta Spa</b> - Via Mecenate, 86 - 20138 Milano (MI) ITALIA Tel. 02/55403211 Telefax 02/55401023	<b>8/32</b>

## User Manual

EN  
IT  
FR  
DE  
ES  
PT

 Qualquer intervenção terá de ser efetuada exclusivamente por pessoal qualificado e, de qualquer modo, antes de qualquer intervenção, é necessário desligar a alimentação elétrica do seccionador.

 A regulação do termostato deve ser feita somente pelo serviço de assistência técnica autorizado.

 Para a montagem de acessórios opcionais dedicados, dirigir-se ao centro de assistência autorizado mais próximo.

 Não deixar o balcão exposto aos agentes atmosféricos.

 Não utilizar jactos de água diretos ou indiretos sobre o balcão.

 Não mexer no balcão com as mãos e os pés molhados ou húmidos e não utilizar o balcão descalços.

 Prestar atenção às partes quentes ou em movimento marcadas com o símbolo adequado.

 Não danificar o circuito refrigerante.

 Evitar fogueiras ou faíscas no interior do aparelho.

 Em caso de incêndio, não utilizar água para apagar as chamas mas apenas extintores a seco.

 Não utilize aparelhos elétricos no interior dos compartimentos do aparelho destinados à conservação de alimentos frescos ou congelados, a menos que sejam do tipo recomendado pelo fabricante.

 Não conservar substâncias explosivas ou perigosas, como recipientes sob pressão com propelente inflamável, neste aparelho.

 Não coloque recipientes com líquidos e não derrame líquidos sobre o balcão.

 Manter livres de obstruções as aberturas de ventilação no invólucro do aparelho.

 A informação relativa à carga máxima de cada tipo de prateleira está disponível na página "27".

 Não deixar pesos em cima da parte superior do balcão; convém evitar colocar alimentos não embalados diretamente nas prateleiras, mas utilizar recipientes específicos para alimentos.

Modello - Modèle - Model Modell - Modelo - Modelo	<b>PROFILE</b>	 epta refrigeration
Fabbricante - Constructeur - Manufacturer Hersteller - Fabricante - Fabricante	<b>Epta Spa</b> - Via Mecenate, 86 - 20138 Milano (MI) ITALIA Tel. 02/55403211 Telefax 02/55401023	<b>9/32</b>

## 2.2 Advertências para a Manutenção do balcão

 As operações de manutenção devem ser realizadas exclusivamente por pessoal autorizado.

 O acesso a partes elétricas e/ou a partes que exigem a utilização de ferramenta é reservado aos técnicos especializados.

 Antes de efetuar qualquer operação de manutenção e limpeza reservadas ao utilizador, retirar tensão ao balcão através do interruptor seccionador geral colocado na parede.

 Prestar atenção às partes quentes ou em movimento marcadas com o símbolo adequado.

 É obrigatório utilizar luvas de trabalho.

 É importante respeitar o tipo e a frequência das inspeções e da manutenção necessárias para um funcionamento seguro, incluindo as medidas de manutenção preventiva, conforme descrito no parágrafo "Limpeza e manutenção ordinária" na página "28".

## 2.3 Advertências elétricas

 Verificar se a tensão de alimentação corresponde aos dados que constam da placa de características do balcão.

 A instalação elétrica tem de ser efetuada, segundo as normas, por técnicos especializados.

 A remoção da tampa do quadro elétrico tem de ser efetuada por técnicos especializados.

 De acordo com as regras de instalação, a rede de alimentação tem de incluir um dispositivo para a desligação onipolar que assegure a desligação completa da rede nas condições da categoria de sobretensão III.

 A instalação do balcão tem de ser efetuada de acordo com as instruções do fabricante, por pessoal profissionalmente qualificado e de acordo com as normas sobre as instalações elétricas em vigor nos vários Países.

 Uma instalação errada do balcão pode provocar danos a pessoas, animais ou coisas, em relação aos quais o fabricante não pode ser considerado responsável.

 Se o cabo de alimentação estiver danificado, deve ser substituído por pessoal de assistência autorizado para evitar qualquer perigo. Não tente reparar o cabo.

 Não ligue a balcão se estiver danificada. Em caso de dúvida, contacte o serviço pós-venda ou o seu revendedor.

EN

IT

FR

DE

ES

PT

Modello - Modèle - Model Modell - Modelo - Modelo	<b>PROFILE</b>	 epta refrigeration
Fabbricante - Constructeur - Manufacturer Hersteller - Fabricante - Fabricante	<b>Epta Spa</b> - Via Mecenate, 86 - 20138 Milano (MI) ITALIA Tel. 02/55403211 Telefax 02/55401023	<b>10/32</b>

## 2.4 Proibições

 É proibido utilizar dispositivos além dos fornecidos no balcão do produtor, para acelerar o processo de descongelamento.

 É proibido, por pessoal não especializado, remover a tampa do quadro elétrico ou abrir painéis que exijem a utilização de ferramenta.

 É proibido utilizar o balcão para a conservação e/ou a exposição de substâncias explosivas, inflamáveis ou corrosivas, como por exemplo embalagens spray com um propelente inflamável.

 É proibido utilizar o balcão para a conservação e/ou a exposição de produtos farmacêuticos.

 É proibido colocar o balcão em ambientes em que estão presentes substâncias gasosas explosivas.

 É proibido remover a placa de características do balcão.

 É proibido subir no balcão ou no pára-choque do balcão.

 É proibida a substituição de componentes e/ou alteração do balcão não correspondente às especificações previstas pelo fabricante, substituição de peças de reposição originais por outras não homologadas pelo fabricante, sob pena da decadência das condições de garantia.

Modello - Modèle - Model Modell - Modelo - Modelo	<b>PROFILE</b>	 epta refrigeration
Fabbricante - Constructeur - Manufacturer Hersteller - Fabricante - Fabricante	<b>Epta Spa</b> - Via Mecenate, 86 - 20138 Milano (MI) ITALIA Tel. 02/55403211 Telefax 02/55401023	<b>11/32</b>

### 3. DESCRIÇÃO GERAL

Aberto



Fig. 2

1. Placa de características
2. Iluminação superior
3. Cortinas nocturnas
4. Prateleiras
5. Vidros lateral
6. Interruptor da luz
7. Teletermóstato

Fechado (Portas de vidro)



Fig. 3

1. Placa de características
2. Iluminação superior
3. Portas de vidro
4. Prateleiras
5. Vidros lateral
6. Interruptor da luz
7. Teletermóstato

EN

IT

FR

DE

ES

PT

Modello - Modèle - Model Modell - Modelo - Modelo	<b>PROFILE</b>	 epta refrigeration
Fabbricante - Constructeur - Manufacturer Hersteller - Fabricante - Fabricante	<b>Epta Spa</b> - Via Mecenate, 86 - 20138 Milano (MI) ITALIA Tel. 02/55403211 Telefax 02/55401023	<b>12/32</b>

## User Manual

EN  
IT  
FR  
DE  
ES  
PT

### Fechado (Portas de vidro deslizantes)



1. Placa de características
2. Iluminação superior
3. Copo portas corrediças
4. Prateleiras
5. Vidros lateral
6. Interruptor da luz
7. Teletermóstato

Modello - Modèle - Model Modell - Modelo - Modelo	<h1>PROFILE</h1>	
Fabbricante - Constructeur - Manufacturer Hersteller - Fabricante - Fabricante	<b>Epta Spa</b> - Via Mecenate, 86 - 20138 Milano (MI) ITALIA Tel. 02/55403211 Telefax 02/55401023	<b>13/32</b>

### 3.1 Seções

#### H20Aberto

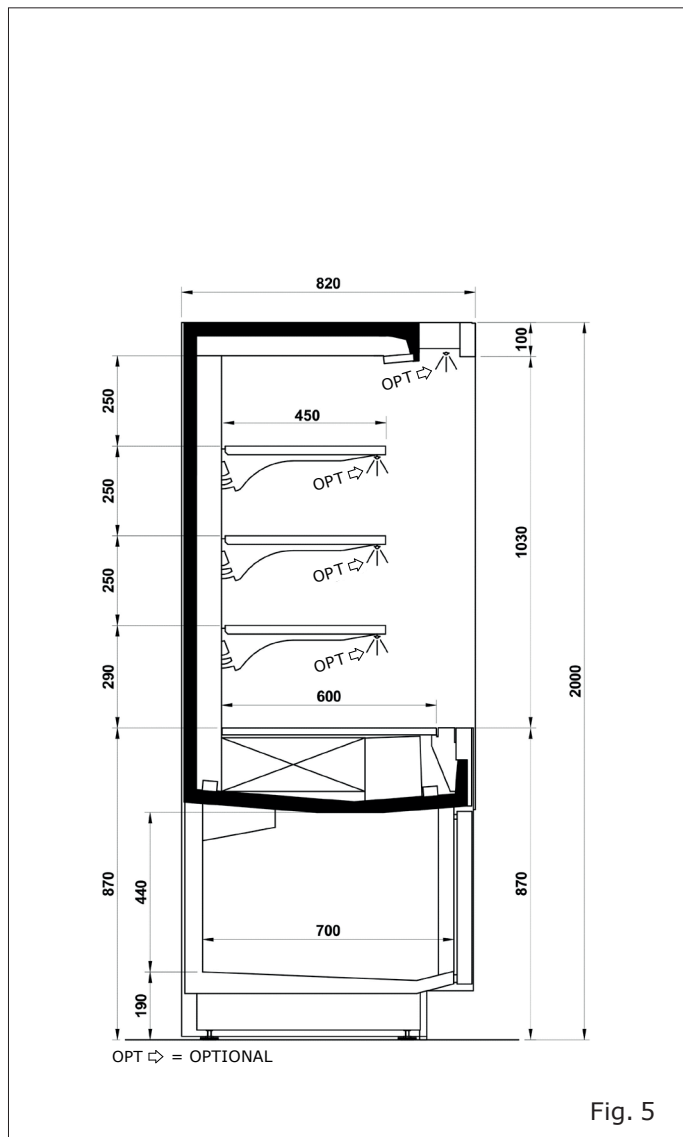

#### H20Aberto com ganchos

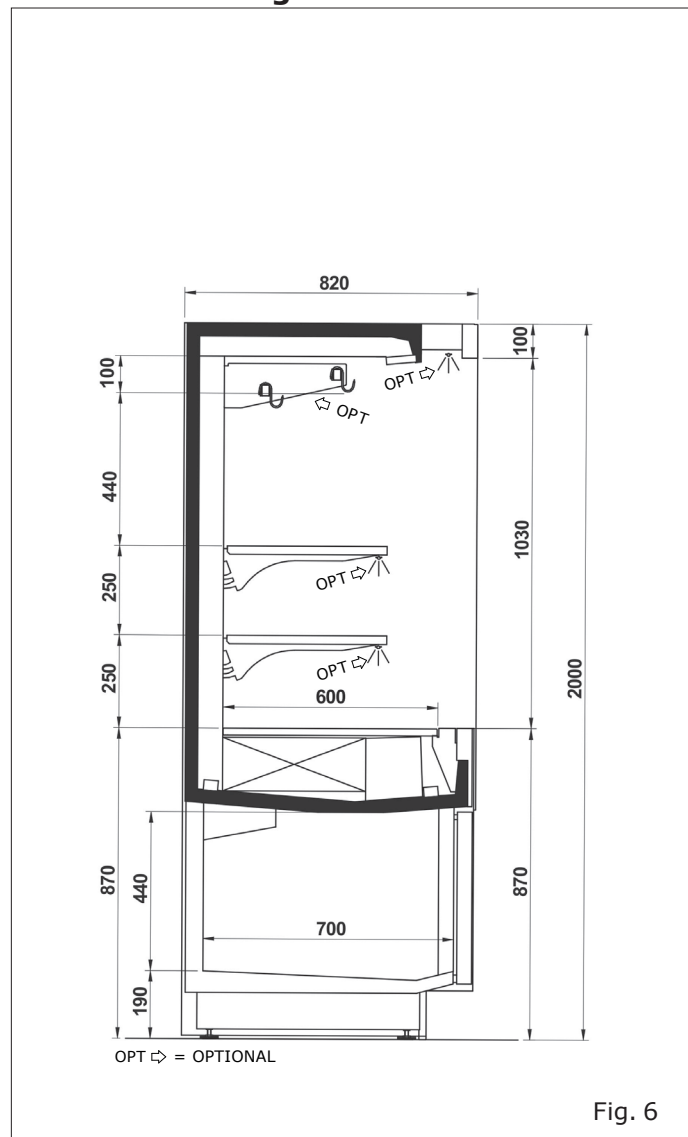

- EN
- IT
- FR
- DE
- ES
- PT**

Modello - Modèle - Model Modell - Modelo - Modelo	<b>PROFILE</b>	 epta refrigeration
Fabbricante - Constructeur - Manufacturer Hersteller - Fabricante - Fabricante	<b>Epta Spa</b> - Via Mecenate, 86 - 20138 Milano (MI) ITALIA Tel. 02/55403211 Telefax 02/55401023	<b>14/32</b>

User Manual

- EN
- IT
- FR
- DE
- ES
- PT

### H20Fechado (Portas de vidro)

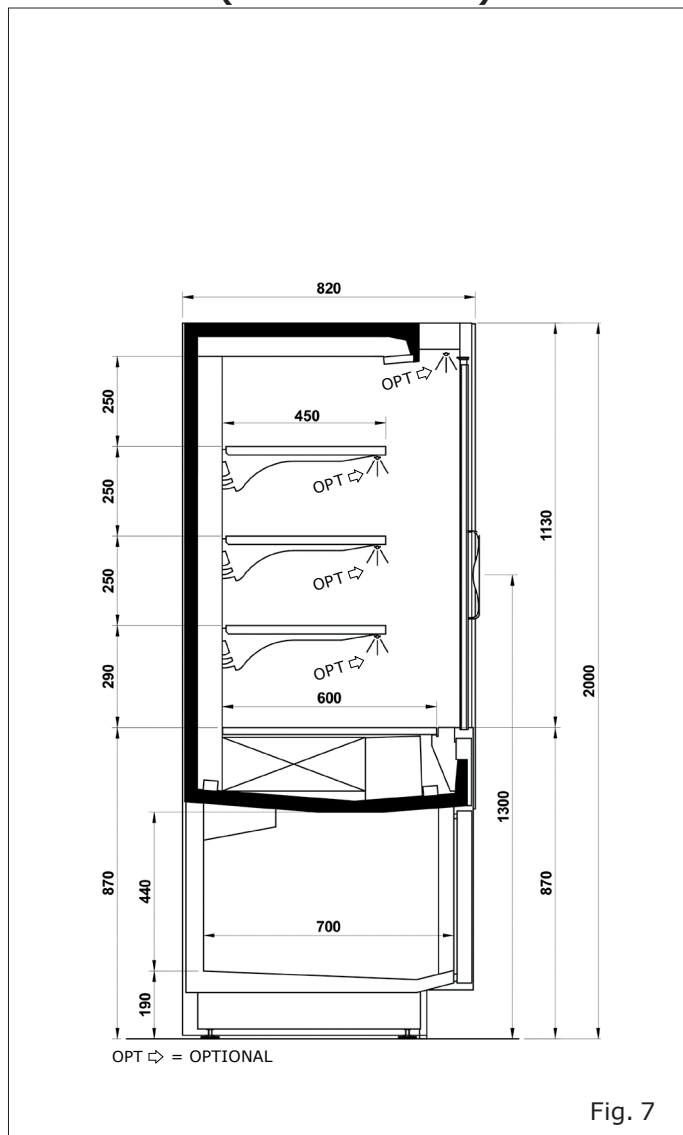

### H20Fechado com ganchos (Portas de vidro)

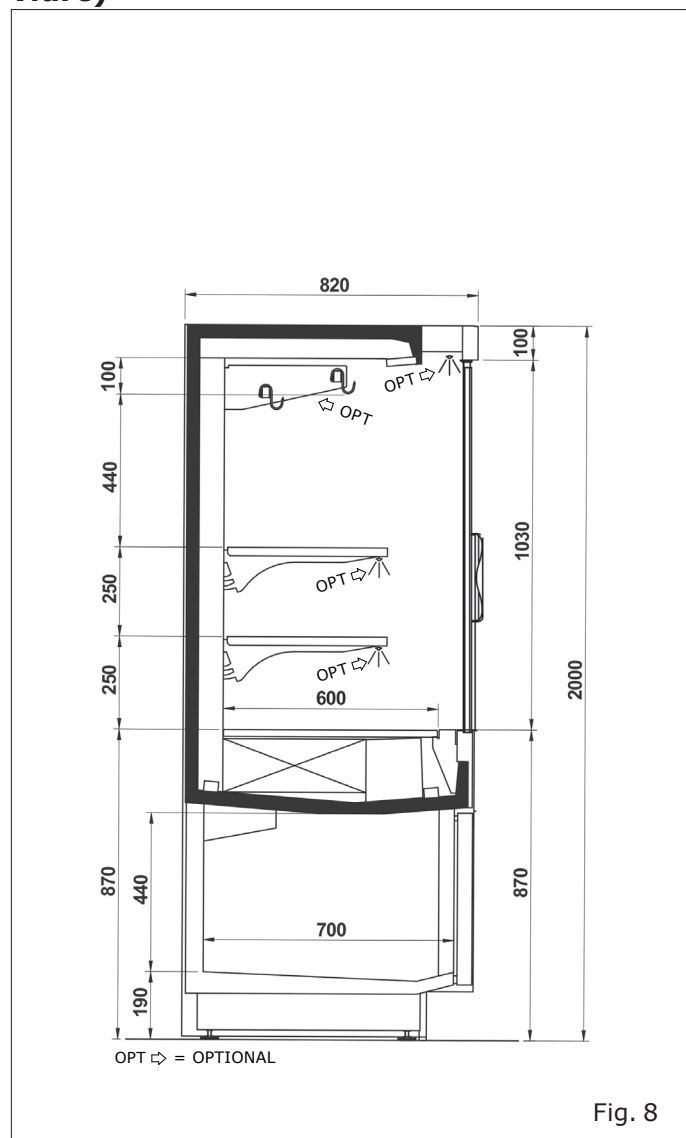



Modello - Modèle - Model Modell - Modelo - Modelo	<b>PROFILE</b>	
Fabbricante - Constructeur - Manufacturer Hersteller - Fabricante - Fabricante	<b>Epta Spa</b> - Via Mecenate, 86 - 20138 Milano (MI) ITALIA Tel. 02/55403211 Telefax 02/55401023	<b>16/32</b>

User Manual

- EN
- IT
- FR
- DE
- ES
- PT

### H22Aberto com ganchos

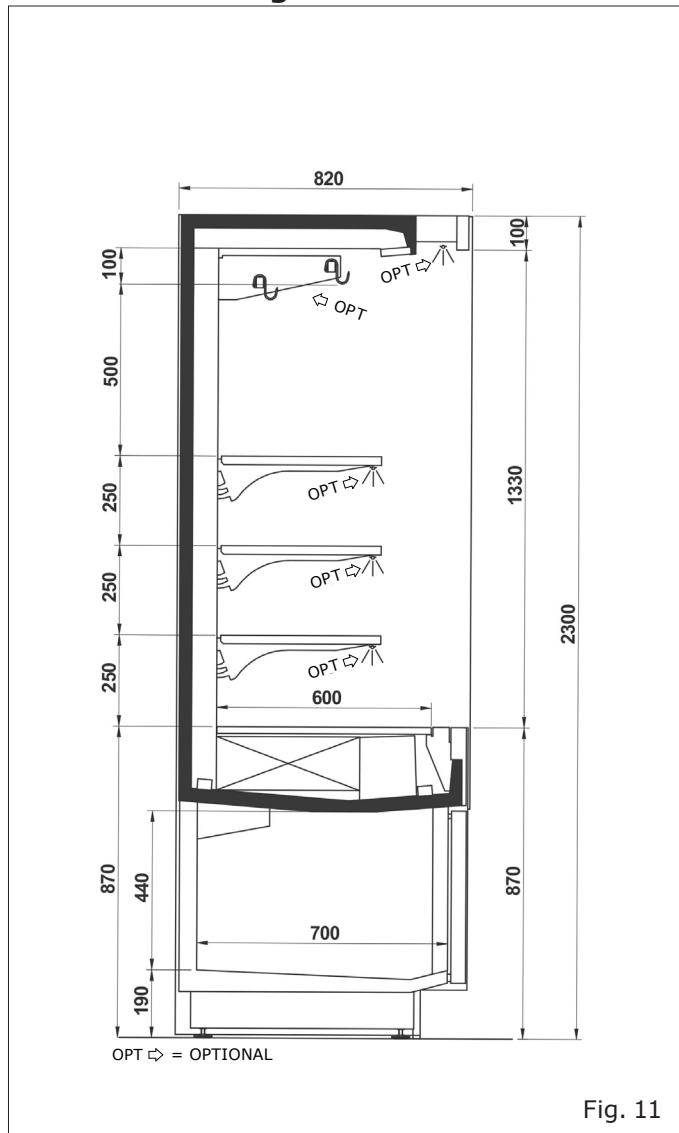

### H22Fechado (Portas de vidro)

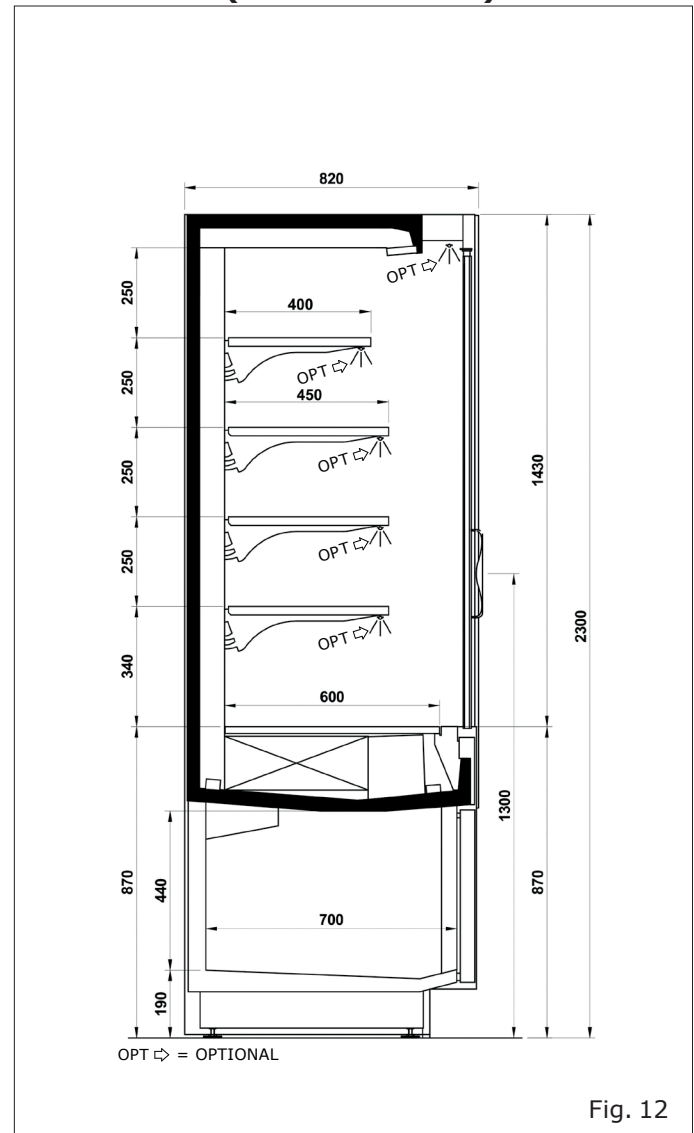

Modello - Modèle - Model Modell - Modelo - Modelo	<b>PROFILE</b>	 epta refrigeration
Fabbricante - Constructeur - Manufacturer Hersteller - Fabricante - Fabricante	<b>Epta Spa</b> - Via Mecenate, 86 - 20138 Milano (MI) ITALIA Tel. 02/55403211 Telefax 02/55401023	<b>17/32</b>

### H22Fechado com ganchos (Portas de vidro)

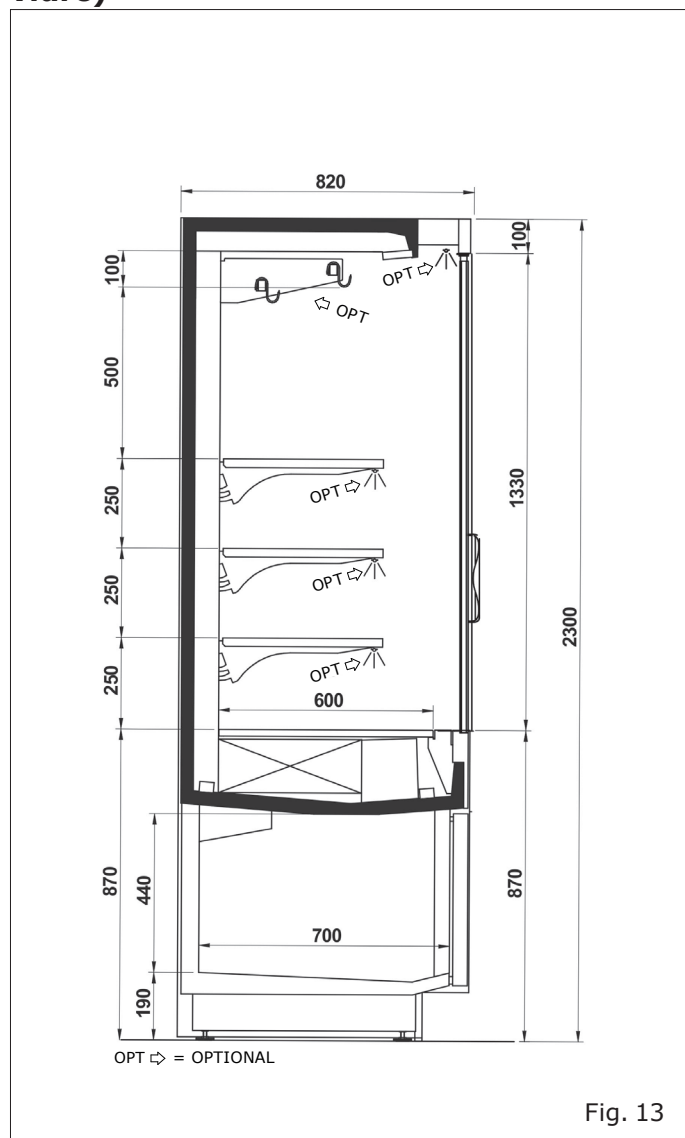

### H22Fechado (Portas de vidro deslizantes)

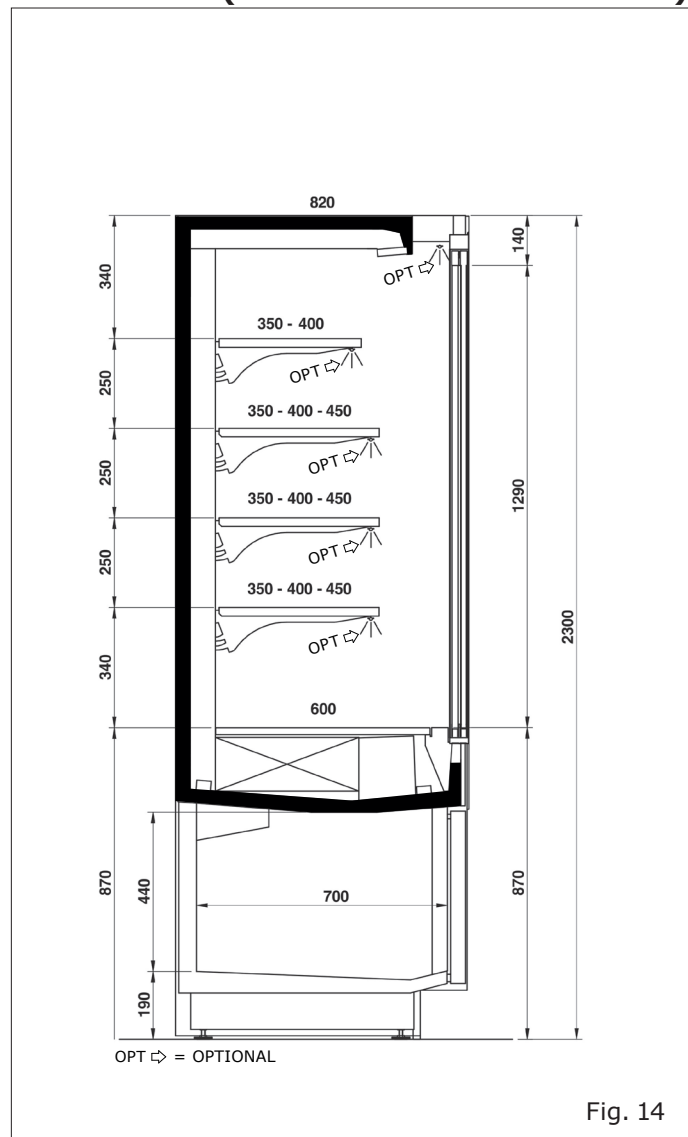

EN

IT

FR

DE

ES

PT



Modello - Modèle - Model Modell - Modelo - Modelo	<b>PROFILE</b>	 eptarefrigeration
Fabbricante - Constructeur - Manufacturer Hersteller - Fabricante - Fabricante	<b>Epta Spa</b> - Via Mecenate, 86 - 20138 Milano (MI) ITALIA Tel. 02/55403211 Telefax 02/55401023	<b>19/32</b>

## 4. TRANSPORTE DO BALCÃO



1. Pontos de levantamento

**Tab. I**

Altura	Comprimento	Peso (kg)	Peso com embalagem (kg)
2000	1250	85	95
	1875	215	240
	2500	365	400
2300	1250	100	120
	1875	250	280
	2500	400	440
2500	1250	115	135
	1875	285	315
	2500	435	475

Modello - Modèle - Model Modell - Modelo - Modelo	<b>PROFILE</b>	 epta refrigeration
Fabbricante - Constructeur - Manufacturer Hersteller - Fabricante - Fabricante	<b>Epta Spa</b> - Via Mecenate, 86 - 20138 Milano (MI) ITALIA Tel. 02/55403211 Telefax 02/55401023	<b>20/32</b>

EN  
IT  
FR  
DE  
ES  
PT

## 5. CONDIÇÕES AMBIENTAIS



**Tab. II**

Caraterísticas	
Tipo de local	Fechado
Temperatura	25°C
Humidade relativa	60 %
Iluminação	600 lx



Modello - Modèle - Model Modell - Modelo - Modelo	<b>PROFILE</b>	 eptarefrigeration
Fabbricante - Constructeur - Manufacturer Hersteller - Fabricante - Fabricante	<b>Epta Spa</b> - Via Mecenate, 86 - 20138 Milano (MI) ITALIA Tel. 02/55403211 Telefax 02/55401023	<b>21/32</b>

## 6. CARACTERÍSTICAS TÉCNICAS

























 <small>EPTA S.p.A. Via Mecenate, 86 20138 Milano - Italy</small>			
			
<b>RATED</b> <b>BEMESSUNG</b> <b>ASSIGNÉ</b> <b>NOMINALE</b> <b>NOMINAL</b>			<b>REFRIGERANT</b> <b>KÄLTEMITTEL</b> <b>RÉFRIGÉRANT</b> <b>REFRIGERANTE</b> <b>REFRIGERANTE</b>
			
<b>DEFROSTING</b> <b>ABTAUUNG</b> <b>DÉGIVRAGE</b> <b>SBRINAMENTO</b> <b>DESCONGELAMIENTO</b>		<b>CLIMATIC CLASS</b> <b>KLIMAKLASSE</b> <b>CLASSE CLIMATIQUE</b> <b>CLASSE CLIMATICA</b> <b>CLASE CLIMÁTICA</b>	
		<b>INSULATION BLOWING GAS</b> <b>ISOLATIONS GAS (BLÄHGAS)</b> <b>AGENT MOUSSANT D'ISOLATION</b> <b>GAS ESPANDENTE ISOLAMENTO</b> <b>AGENTE ESPUMANTE</b>	
		<b>PROTECTION INDEX</b> <b>SCHÜTZART</b> <b>INDEX DE LA PROTECTION</b> <b>INDICE DI PROTEZIONE</b> <b>ÍNDICE DE PROTECCIÓN</b>	
			
			  
<small>Read Operator's Manual available at www.eptarefrigeration.com or calling: +39 0437 968379</small>			

Fig. 20

- |  |   |
|--|---|
| <ol style="list-style-type: none"> <li>1. Origem do produto</li> <li>2. Produto no "País de origem"</li> <li>3. Tensão nominal</li> <li>4. Potência nominal</li> <li>5. Frequência nominal</li> <li>6. Corrente nominal</li> <li>7. Potência de descongelamento</li> <li>8. Corrente de descongelamento</li> <li>9. Sistema de aquecimento</li> <li>10. Sistema de iluminação</li> <li>11. Manual do operador</li> <li>12. Código de barras</li> </ol> | <ol style="list-style-type: none"> <li>13. Número de série</li> <li>14. Data de produção</li> <li>15. Código hat</li> <li>16. Modelo/designação</li> <li>17. Tipo de refrigerante 1</li> <li>18. Massa refrigerante 1</li> <li>19. Tipo de refrigerante 2</li> <li>20. Massa refrigerante 2</li> <li>21. Classe climática</li> <li>22. Isolamento gás</li> <li>23. Índice de proteção</li> <li>24. Marca de certificação</li> </ol> |
|--|---|

### 6.1 Referência dos modelos / designação

A tabela explica como ler o código do modelo, indicando as informações comerciais relevantes para cada parte da referência (ver campo da etiqueta número: "16").

#### PROFILE xxx (Móvel refrigerado)

Referência / designação	Descrição geral	Informações comerciais
Profile	Nome	Profile
xxx	Comprimento	125(1250), 188(1875), 250(2500)

exemplo:  
Profile125 = Profile 1250

Modello - Modèle - Model Modell - Modelo - Modelo	<b>PROFILE</b>	 epta refrigeration
Fabbricante - Constructeur - Manufacturer Hersteller - Fabricante - Fabricante	<b>Epta Spa</b> - Via Mecenate, 86 - 20138 Milano (MI) ITALIA Tel. 02/55403211 Telefax 02/55401023	<b>22/32</b>

- EN
- IT
- FR
- DE
- ES
- PT

## 7. UTILIZAÇÃO DO BALCÃO



 Não tapar

Apenas para o modelo aberto

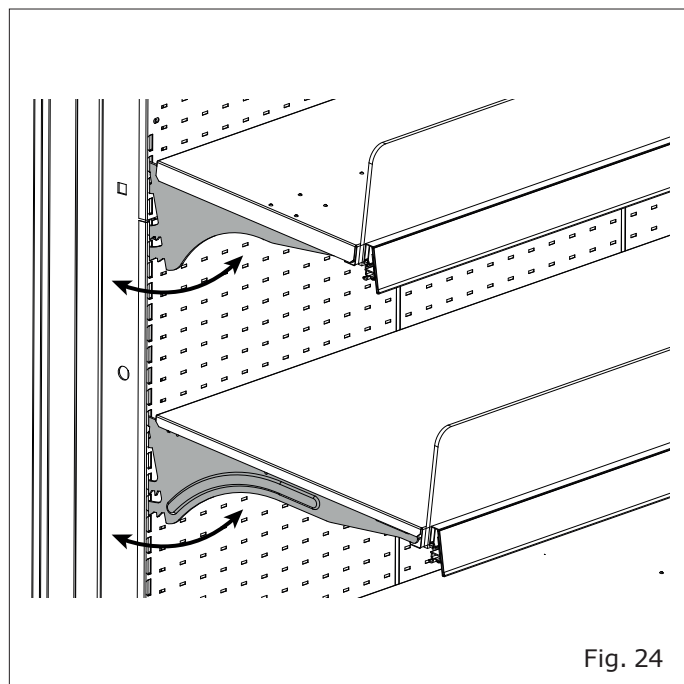

Inclinação das prateleiras: 0° - 7° - 14° - 21°

Modello - Modèle - Model Modell - Modelo - Modelo	<h1>PROFILE</h1>	
Fabbricante - Constructeur - Manufacturer Hersteller - Fabricante - Fabricante	<b>Epta Spa</b> - Via Mecenate, 86 - 20138 Milano (MI) ITALIA Tel. 02/55403211 Telefax 02/55401023	<b>23/32</b>



- EN
- IT
- FR
- DE
- ES
- PT

Modello - Modèle - Model Modell - Modelo - Modelo	<b>PROFILE</b>	 epta refrigeration
Fabbricante - Constructeur - Manufacturer Hersteller - Fabricante - Fabricante	<b>Epta Spa</b> - Via Mecenate, 86 - 20138 Milano (MI) ITALIA Tel. 02/55403211 Telefax 02/55401023	<b>24/32</b>

- EN
- IT
- FR
- DE
- ES
- PT**

## 8. MANUTENÇÃO ORDINÁRIA

### 8.1 Limpeza do balcão

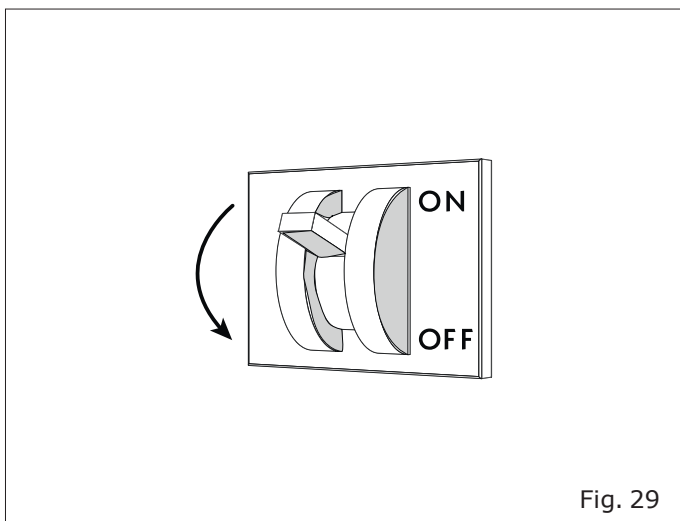

Modello - Modèle - Model Modell - Modelo - Modelo	<b>PROFILE</b>	 epta refrigeration
Fabbricante - Constructeur - Manufacturer Hersteller - Fabricante - Fabricante	<b>Epta Spa</b> - Via Mecenate, 86 - 20138 Milano (MI) ITALIA Tel. 02/55403211 Telefax 02/55401023	<b>25/32</b>

## 9. CONFIGURAÇÃO DE PRATELEIRAS

Tab. III

Configuração de prateleira de profundidade única			
Nível	Com ganchos	Sem ganchos	H20
1	x	x	350-400-450 350-400-450
2	x	x	350-400-450 350-400-451
3	x	-	350-400-450 350-400-452

Configuração de prateleira de profundidade única			
Nível	Com ganchos	Sem ganchos	H23
1	x	x	350-400-450 350-400-450
2	x	x	350-400-450 350-400-451
3	x	x	350-400-450 350-400-452
4	x	-	350-400-450 350-400-453

Modello - Modèle - Model Modell - Modelo - Modelo	<b>PROFILE</b>	 <small>epta refrigeration</small>
Fabbricante - Constructeur - Manufacturer Hersteller - Fabricante - Fabricante	<b>Epta Spa</b> - Via Mecenate, 86 - 20138 Milano (MI) ITALIA Tel. 02/55403211 Telefax 02/55401023	<b>26/32</b>

## 10. INDICAÇÕES PARA O UTILIZADOR

### 10.1 Descrição do balcão

O móvel foi projectado e realizado exclusivamente para expor produtos alimentares frescos já embalados, bebidas e lacticínios.

CLASSE DE TEMPERATURA (segundo EN ISO 23953-2):

- Aberto H20/H23: 3M1/3M2, H26: 3M2
- Fechado H20/H23/H26: 3M1

As características gerais e as dimensões são ilustradas nas figuras e nas seções contidas em "Descrição geral" (a partir da pág. "11" até à pág. "18").

As configurações de temperatura recomendadas para cada compartimento, para uma conservação ideal dos alimentos, estão indicadas na ficha de informação do produto disponível em EPREL ou através do acesso ao site <https://eprel.eptarefrigeration.com>, seguindo as instruções fornecidas para o acesso à base de dados.

Durante as fases de transporte e movimentação, receção e armazenagem, instalação, carregamento, utilização, limpeza e manutenção, eliminação, prestar atenção ao risco de viragem do balcão ("Fig. 31").

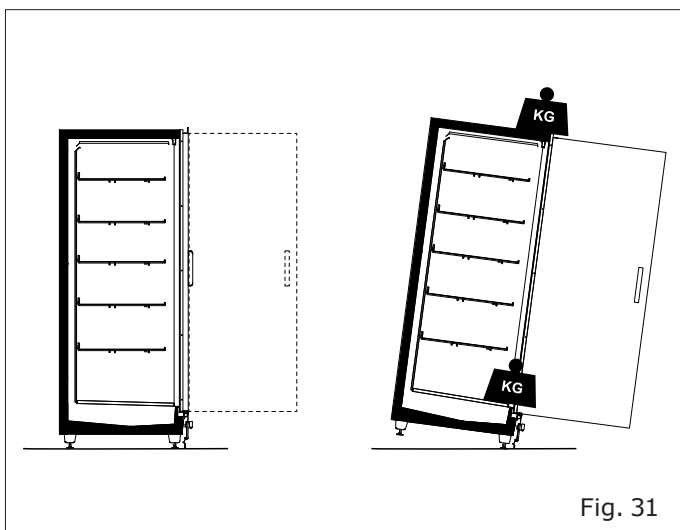

Fig. 31

### 10.2 Transporte e movimentação

O balcão é contido numa embalagem específica dotada de estrado para a movimentação com empilhadores.

Para o transporte e a movimentação do balcão utilizar:

- Exclusivamente um estrado adequado ou equivalente
- Um empilhador à mão ou elétrico adequado para o levantamento do balcão, com características idóneas que respeitem as Normas em vigor

Os pesos do balcão (vazio e com a embalagem) e as dimensões da embalagem encontram-se em "Transporte do balcão" (tabela "Tab. I" e figuras na pág. "19").

As operações de movimentação devem ser efetuadas por pessoal qualificado, apto para avaliar pesos, pontos de levantamento e meios mais idóneos tanto para a segurança como para o caudal.

### 10.3 Receção e armazenagem

Controlar as condições de embalagem antes de aceitar a entrega do balcão pelo despachante.

Em caso de danos evidentes na embalagem:

- Remover a embalagem do balcão em presença do despachante.
- Assinar, com reserva, o documento de entrega.

O fabricante não pode ser responsabilizado por eventuais danos devido ao transporte ou a uma armazenagem errada do balcão.

O balcão tem de ser conservado em lugar protegido do sol e das intempéries, a uma temperatura entre -25°C e +55°C e uma humidade relativa do ar entre 30% e 95%.

Modello - Modèle - Model Modell - Modelo - Modelo	<b>PROFILE</b>	 eptarefrigeration
Fabbricante - Constructeur - Manufacturer Hersteller - Fabricante - Fabricante	<b>Epta Spa</b> - Via Mecenate, 86 - 20138 Milano (MI) ITALIA Tel. 02/55403211 Telefax 02/55401023	<b>27/32</b>

## 10.4 Instalação e condições ambientais

O balcão não foi projetado para ser instalado no exterior.

Para um funcionamento correto do balcão, verificar se está posicionado:

- Num chão nivelado ("Fig. 18").
- Longe de fontes de calor, da radiação direta do sol, de portas, janelas, ventiladores e bocas de ventilação ("Fig. 19").

Assegurar o espaço necessário para os clientes que utilizam o balcão.

As condições do ambiente no qual colocar o balcão encontram-se em: "Condições ambientais" (tabela "Tab. II", Pág."20").

## 10.5 Ligação elétrica

A montante do balcão tem de ser instalado um interruptor seccionador omni polar. Este tem de ter poder de interrupção adequado.

O interruptor-seccionador deve estar instalado a montante do balcão e deve ser visível para o operador durante a limpeza e a manutenção, ou deve estar equipado com um seccionador com sistema de bloqueio em posição isolada.

Antes de ligar o balcão, verificar se a tensão de alimentação corresponde aos dados que constam da placa de características do balcão. Para garantir um funcionamento regular, a variação máxima de tensão tem de estar incluída entre +/- 6% do valor nominal.

## 10.6 Características técnicas

A placa de características indica os dados técnicos do balcão. A sua posição e a tipologia de dados encontram-se em: "Características técnicas" ("Fig. 20").

Esquemas elétricos, listas de calibrações dos instrumentos de controle, instruções de instalação e cópia da Declaração de Conformidade estão disponíveis no site <https://documents.eptarefrigeration.com>.

O nível de pressão sonora gerado pelo funcionamento do balcão é inferior a 70 dB(A). O balcão não provoca vibrações prejudiciais.

## 10.7 Carregamento do produto

Transmitir tensão ao balcão para iniciar o seu ciclo de arrefecimento, carregando no interruptor seccionador geral colocado na parede. Depois de cerca 2 horas é possível carregar o balcão.

O balcão é adequado para conservar a temperatura da mercadoria e não para a baixar; los alimentos, portanto, terão de ser colocados no seu interior apenas se tiverem sido arrefecidos segundo as respetivas temperaturas de conservação. Produtos que tiverem sofrido aquecimento nunca devem ser colocados no balcão.

Em presença de vidros na parte da frente do balcão, aconselha-se efetuar o carregamento da mercadoria quando no espaço de venda não estiverem presentes clientes.

Durante o carregamento da mercadoria, fazer com que:

- A carga seja homogénea por dimensão e qualidade da mesma mercadoria.
- A mercadoria não obstrua o correto fluxo do ar refrigerado ("Fig. 21")
- A mercadoria não ultrapasse a linha de carga.
- A parte superior do balcão não deve ser carregada ("Fig. 25").

Carga máxima admissível distribuída de modo uniforme:

- Na prateleira ao fundo: 225 kg/m<sup>2</sup>
- Nas prateleiras: 140 kg/m<sup>2</sup>
- Do total de prateleiras: MAX 420 kg/m<sup>2</sup> (3 prateleiras) - 560 kg/m<sup>2</sup> (4 prateleiras)

Modello - Modèle - Model Modell - Modelo - Modelo	<b>PROFILE</b>	 epta refrigeration
Fabbricante - Constructeur - Manufacturer Hersteller - Fabricante - Fabricante	<b>Epta Spa</b> - Via Mecenate, 86 - 20138 Milano (MI) ITALIA Tel. 02/55403211 Telefax 02/55401023	<b>28/32</b>

## 10.8 Utilização do balcão



Para um melhor funcionamento do móvel, recomendamos verifique que as portas não estão abertas.

### Iluminação

A iluminação do balcão é comandada por um interruptor colocado no balcão, na parte inferior à direita.

### Termóstato/termómetro

No balcão, na parte inferior à direita, está posicionado um termóstato/termómetro remoto para o controle da temperatura ("Fig. 2", "Fig. 3", "Fig. 4").

O termóstato remoto visualiza a temperatura existente no interior da carcaça e permite o controle da temperatura através das teclas específicas.

### Configuração e inclinação das prateleiras de exibição

Assegurar o desempenho correto para o que o móvel foi projetado, devem ser organizadas estantes dentro do móvel de acordo com o jogo-para cima descreveu abaixo (tabela "Tab. III" até à pág."25").

Podem assumir 4 inclinações diferentes, que são reguladas variando a posição de encaixe das prateleiras nos montantes posteriores do móvel. ("Fig. 24").

Apenas para o modelo aberto



Usar as tampas anti-dispersão, se estivessem instaladas, durante as horas de fechamento. ("Fig. 22").

Apenas para modelo fechado



Nunca deixe as portas de vidro abertas ou entreabertas. Se aconselha de verificar frequentemente que todas as portas estejam fechadas: se evita assim inúteis consumos de energia e formações de condensas nas paredes obtendo no mesmo tempo uma melhor conservação dos produtos expostos.

## 10.9 Limpeza e manutenção ordinária

Fazer com que haja uma boa visibilidade na área de intervenção, eventualmente servindo-se de mais uma fonte de iluminação.

### Limpeza do balcão

Utilizar exclusivamente água à temperatura máxima de 65°C e sabão ou detergente neutro para uso doméstico diluído em água.

Para as superfícies envidraçadas utilizar exclusivamente produtos para a limpeza dos vidros. Aconselha-se evitar a utilização de água porque poderia depositar calcário na superfície do vidro.

Não utilizar por nenhuma razão:

- Esponjas abrasivas
- Produtos inflamáveis ou abrasivos como álcool, acetona ou solventes
- Detergentes que contêm tensoativos não iónicos, limão ou vinagre (ácido acético)



Não lavar ou limpar com água ou líquidos a parte superior do balcão.

Limpar **UMA VEZ POR SEMANA** todas as partes exteriores do balcão.

Limpar **UMA VEZ POR MÊS** todas as partes interiores do balcão, seguindo as instruções abaixo indicadas:

- Retirar a tensão elétrica ao balcão através do interruptor seccionador geral colocado na parede ("Fig. 29").
- Esvaziar o balcão, armazenando a mercadoria em câmaras frigoríficas ou refrigeradores específicos para manter a temperatura de conservação da mesma.
- Aguardar que o interior do balcão tenha alcançado a temperatura ambiente e proceder à limpeza
- Depois de ter controlado com atenção que o interior do balcão esteja completamente seco, colocar de novo em função o aparelho, transferindo tensão ao balcão.
- Depois de cerca duas horas colocar de novo a mercadoria.

Modello - Modèle - Model Modell - Modelo - Modelo	<b>PROFILE</b>	 epta refrigeration
Fabbricante - Constructeur - Manufacturer Hersteller - Fabricante - Fabricante	<b>Epta Spa</b> - Via Mecenate, 86 - 20138 Milano (MI) ITALIA Tel. 02/55403211 Telefax 02/55401023	<b>29/32</b>

Quando se colocar o armário fora de serviço, desligar a alimentação e seguir os passos anteriores, deixando as portinholas abertas (se disponível) para evitar maus cheiros.

Proceder **CADA TRÊS MESESI** o descongelamento do balcão para permitir o derretimento do gelo que porventura se formou na alhetas do evaporador não permitindo o funcionamento correto. A duração e o número de descongelamentos são regulados diretamente na fábrica. Eventuais regulações são reservadas exclusivamente ao serviço técnico de assistência. A água de descongelamento é recolhida numa descarga adequada. Verificar periodicamente se a água de descongelamento escorre normalmente. Em caso contrário intervir mediante uma sonda flexível não pontiaguda.

Atuar como indicado para a limpeza **MENSAL** das partes interiores, mas neste caso será necessário prever um tempo de espera mais longo para permitir o descongelamento completa do gelo.

### 10.10 Situações de emergência

#### O balcão não arranca ou pára:

- Verificar que não esteja presente uma situação de blackout elétrico.
- Controlar que o interruptor geral colocado na esteja ligado.
- Controlar que a ficha do balcão esteja introduzida na tomada de corrente.

Se a interrupção elétrica não depender destas razões, dirigir-se ao centro de assistência autorizado mais próximo e proceder ao esvaziamento completo e à armazenagem imediata do produto em arcas frigoríficas ou refrigeradores específicos para manter a temperatura de conservação.

#### O balcão não arrefece suficientemente:

- Controlar se o carregamento do balcão está correto.
- Descongelar o balcão para depois retomar o funcionamento normal.
- Controlar que o balcão não se encontre próximo de fontes de calor ou correntes de ar.
- Verificar as condições ambientais indicadas em "Condições ambientais" ("Tab. II", Pág."20").
- Controlar, através de uma bolha de nível, a planaridade do balcão.

Se a falha de arrefecimento persistir, dirigir-se ao centro de assistência autorizado mais próximo.

#### O balcão faz ruído:

- Controlar se os parafusos e as porcas estão perfeitamente fechados.
- Controlar, através de uma bolha de nível, a planaridade do balcão.

Se o inconveniente persistir, dirigir-se ao centro de assistência autorizado mais próximo.

### 10.11 Assistência técnica

Se se tornar necessária a intervenção do pessoal técnico de assistência, contactar de imediato o fornecedor que vendeu o balcão.

Se se tornar necessária a utilização de peças sobresselentes remeter-se sempre ao serviço técnico de assistência: pedir e apurar que sejam utilizadas peças sobresselentes originais.

Modello - Modèle - Model Modell - Modelo - Modelo	<b>PROFILE</b>	 epta refrigeration
Fabbricante - Constructeur - Manufacturer Hersteller - Fabricante - Fabricante	<b>Epta Spa</b> - Via Mecenate, 86 - 20138 Milano (MI) ITALIA Tel. 02/55403211 Telefax 02/55401023	<b>30/32</b>

- EN
- IT
- FR
- DE
- ES
- PT**

## 10.12 Desmantelamento e eliminação

De acordo com as normas para o desmantelamento dos resíduos em vigor em cada País e respeitando o ambiente no qual vivemos, pedimos para dividirem o balcão em duas partes por forma a poder eliminar separadamente e eventualmente recuperá-las adequadamente.

Todas as partes que compõem o balcão não são assimiladas aos resíduos sólidos urbanos, excepto para peças metálicas que, no entanto, não estão incluídas entre os resíduos especiais para a maioria dos Países Europeus.



O sistema de refrigeração é de alta pressão. Contactar pessoal especializado no desmantelamento.

Os componentes do circuito de refrigeração não devem ser cortados e/ou separados antes que seja desligado o circuito, sendo a recuperação do gás refrigerante efetuada por pessoal qualificado.

Modello - Modèle - Model Modell - Modelo - Modelo	<b>PROFILE</b>	 eptarefrigeration
Fabbricante - Constructeur - Manufacturer Hersteller - Fabricante - Fabricante	<b>Epta Spa</b> - Via Mecenate, 86 - 20138 Milano (MI) ITALIA Tel. 02/55403211 Telefax 02/55401023	<b>31/32</b>

## 11. ADVERTÊNCIAS GERAIS ADICIONAIS

### Instruções para a instalação e manutenção corretas

As instruções de utilização e manutenção encontram-se no Manual do Utilizador disponível no site:

[www.eptarefrigeration.com](http://www.eptarefrigeration.com).

As instruções de instalação destinadas ao pessoal especializados estão disponíveis:

- Junto da rede de assistência
- Em algumas categorias de produto em papel entregue junto com o produto

### Informações do produto

As informações do produto (EPREL) estão disponíveis acessando o site <https://eprel.eptarefrigeration.com> e seguindo as instruções indicadas para aceder à base de dados.

### Garantia

O produto é coberto por garantia, nos termos de lei, por um período de 12 meses, a não ser se existirem acordos diferentes assinados explicitamente pelas partes.

### Serviços profissionais de reparação

Os serviços são distribuídos pela nossa rede de assistência que pode ser consultada na área dos contactos no endereço web [www.eptarefrigeration.com](http://www.eptarefrigeration.com).

### Peças sobresselentes

As peças sobresselentes e as informações para a reparação do aparelho estão disponíveis por pelo menos 8 anos depois do produto ter sido declarado fora de produção, no seguinte endereço web: [www.epta-service.com/service](http://www.epta-service.com/service). As credenciais de acesso são fornecidas a pedido a remeter por email para: [servicesupport@eptarefrigeration.com](mailto:servicesupport@eptarefrigeration.com).

### Informação importante sobre os desperdícios de alimentos

Recomenda-se seguir com atenção as instruções de conservação indicadas nas embalagens dos produtos e as indicações fornecidas pelos produtores de alimentos.

Portanto, as seleções da temperatura devem ser adequadas às características de conservação dos produtos alimentares de acordo com as indicações que constam da nossa documentação técnica.

Utilizações não corretas podem causar deterioração.

### Condições ambientais

O presente aparelho foi projetado para funcionar em ambientes em que a temperatura e a humidade não excedem os limites previstos no Manual de utilização e manutenção.

### Instruções para a desembalagem

Para a desembalagem é necessário dirigir-se a operadores profissionais.

O grupo Epta, desde sempre animado por um enfoque especial para o ambiente, disponibiliza para os usuários os manuais de eliminação e tratamento dos resíduos, que podem ser baixados a seguir.

- Acesse o site [www.bonnetneve.com](http://www.bonnetneve.com)

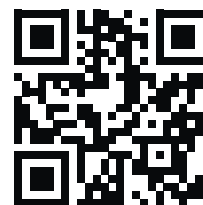

- Acesse a seção **área técnica** do gabinete.

Modello - Modèle - Model Modell - Modelo - Modelo	<b>PROFILE</b>	 eptarefrigeration
Fabbricante - Constructeur - Manufacturer Hersteller - Fabricante - Fabricante	<b>Epta Spa</b> - Via Mecenate, 86 - 20138 Milano (MI) ITALIA Tel. 02/55403211 Telefax 02/55401023	<b>32/32</b>

## User Manual

EN  
IT  
FR  
DE  
ES  
PT

### Outras informações

Para maiores e detalhadas informações remeter-se a [www.eptarefrigeration.com](http://www.eptarefrigeration.com) e à EPREL à qual se acede através do código QR presente ou na etiqueta energética do produto.



### Limites de aplicação



Este balcão foi projetado para a utilização, transporte e armazenamento até uma altitude máxima de 2000 m sobre o nível do mar.

#### Armazenagem:

- Temperatura entre 15°C e 50°C
- Humidade relativa entre 20% e 90%
- Tempo máximo 6 meses

#### Transporte:

- Temperatura entre 20°C e 70°C
- Humidade relativa entre 20% e 90%
- Tempo máximo 2 meses

### Utilização:

A classe climática de utilização é indicada na placa de características.

Abaixo segue um extrato da Norma de referência, que esclarece o significado dos caracteres alfanuméricos:

Classe climática	Temperatura de bulbo seco	Humidade relativa
[-]	[°C]	[%]
0	20	50
1	16	80
8	24	55
2	22	65
3	25	60
4	30	55
6	27	70
5	40	40
7	35	75

EXEMPLO Classe climática 3 significa 25°C / 60%HR

### Desempenho



As condições ambientais exteriores necessárias para o correto funcionamento do balcão estão especificadas na placa de características.

Os desempenhos do balcão não são garantidos para além da sua utilização normal.



A temperatura mínima não deve ser inferior a 16°C.

Modello - Modèle - Model Modell - Modelo - Modelo	<h1>PROFILE</h1>	 <small>epta refrigeration</small>
Fabbricante - Constructeur - Manufacturer Hersteller - Fabricante - Fabricante	<b>Epta Spa</b> - Via Mecenate, 86 - 20138 Milano (MI) ITALIA Tel. 02/55403211 Telefax 02/55401023	<b>33/35</b>

EN

IT

FR

DE

ES

PT

Modello - Modèle - Model Modell - Modelo - Modelo	<h1>PROFILE</h1>	
Fabbricante - Constructeur - Manufacturer Hersteller - Fabricante - Fabricante	<b>Epta Spa</b> - Via Mecenate, 86 - 20138 Milano (MI) ITALIA Tel. 02/55403211 Telefax 02/55401023	<b>34/35</b>

User Manual

EN

IT

FR

DE

ES

PT



Epta S.p.A. participates in the ECC programme for Refrigerated display cabinets (RDC). Check ongoing validity of certificate online: [www.eurovent-certification.com](http://www.eurovent-certification.com)

