

KALEIDO CLOSED

Mozaik / Multideck
Serve-over



BEST ENERGY CLASS*



Product Categories

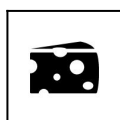

Cheese

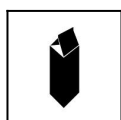

Dairy products



Delicatessen

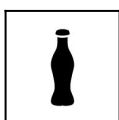

Drinks

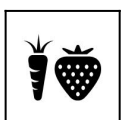

Fruit and Vegetables



Meat



Pastries

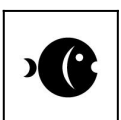

Pre-packed fish



Pre-packed fruit and vegetables

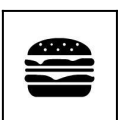

Sandwiches



Chicken

KALEIDO CLOSED

Mozaik / Multideck

Serve-over

Technical Features



High
efficiency
fans



LED lighting



Natural
Defrost Plus

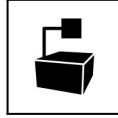

Remote
condensing
unit



Ventilated

Certification and Patents



Eurovent

Product Range

KALEIDO CLOSED

Mozaik / Multideck
Serve-over



KALEIDO CLOSED										
Length-Lunghezza Longueur-Länge-Longitud		mm	1250	1875	2500	3750	EOL1822	EOL2016	EOL2225	
KALEIDO CLOSED	DESIGN	S	H1200	•	•	•	•	•		
			H1400	•	•	•	•			
			H1600	•	•	•	•			
		E	H1200	•	•	•	•		•	
			H1400	•	•	•	•		•	
			H1600							
	M	H1200	•	•	•	•			•	
		H1400	•	•	•	•				
		H1600	•	•	•	•				
	STUDIO	S	H1200					•		
			H1400							
			H1600							
		E	H1200	•	•	•	•		•	
			H1400	•	•	•	•		•	
			H1600							
	M	H1200	•	•	•	•			•	
		H1400								
		H1600	•	•	•	•				
	STYLE	S	H1200					•		
			H1400							
			H1600							
		E	H1200	•	•	•	•		•	
			H1400	•	•	•	•		•	
			H1600							
M	H1200	•	•	•	•			•		
	H1400									
	H1600	•	•	•	•					
Display area Superficie di esposizione Warenpräsentationsfläche Surface d'exposition Superficie expositiva m ²	Slim	H1200	0.81	1.23	1.62	2.44	1.56			
		H1400	1.09	1.63	2.17	3.26				
		H1600	1.33	2.01	2.66	3.99				
	Efficia	H1200	0.90	1.36	1.81	2.71		1.82		
		H1400	1.18	1.78	2.36	3.54		2.37		
		H1600								
	Modular	H1200	1.03	1.55	2.05	3.08			2.21	
		H1400								
		H1600	1.55	2.33	3.69	4.04				
Loading area Superficie di appoggio Nutzfläche Surface de chargement Superficie de apoyo m ²	Slim		1.17	1.76	2.35	3.52		1.76		
	Efficia		1.30	1.95	2.60	3.90		2.09		
	Modular		1.42	2.13	2.85	4.27		2.53		
End thickness Spessore spalla Stärke der Seitenwand Épaisseur de chevet Espesor lateral mm	30.00 (+ 35 Batticarrello/Bumper Rail/Pare-choc/Wagenstoßleiste/Parachoques)									

KALEIDO CLOSED

Mozaik / Multideck

Serve-over



Cross Sections

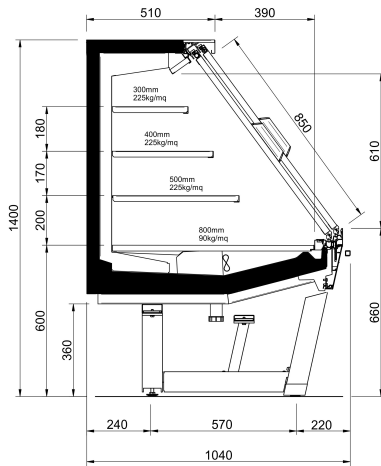

Kaleido Closed H14 E Style

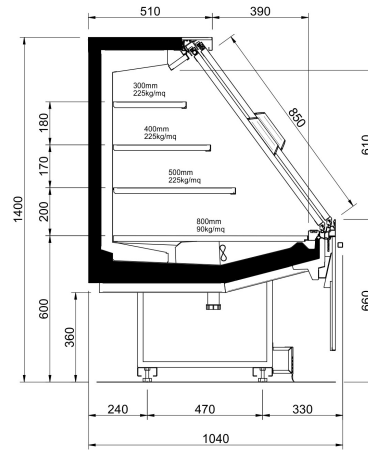

Kaleido Closed H14 E Design

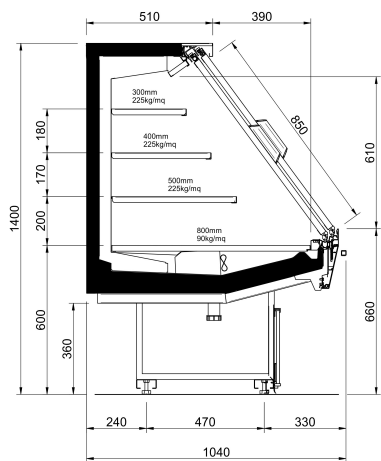

Kaleido Closed H14 E Studio

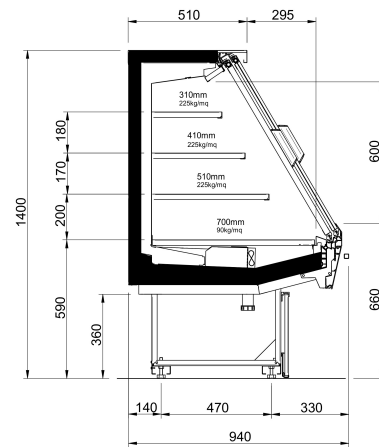

Kaleido Closed 14 S Studio

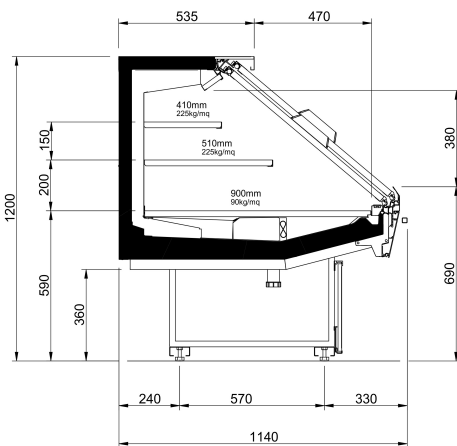

Kaleido Closed 12 N Studio

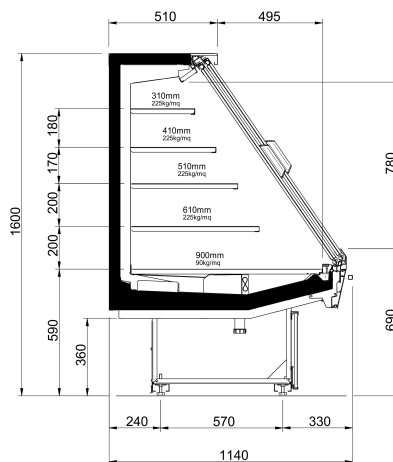

Kaleido Closed 16 N Studio

KALEIDO CLOSED

Mozaik / Multideck
Serve-over

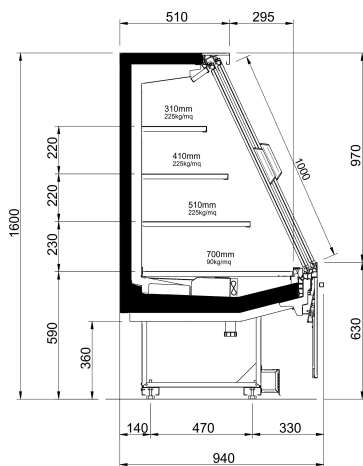

Kaleido Closed 16 S Design

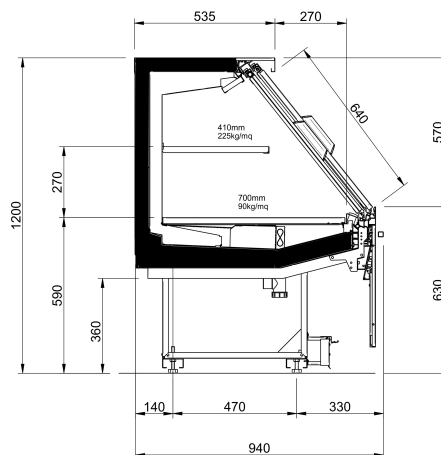

Kaleido Closed 12 S Design

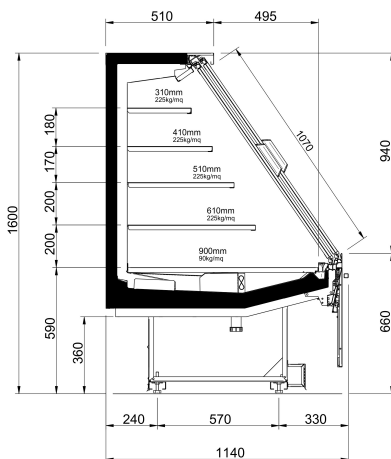

Kaleido Closed 16 M Design

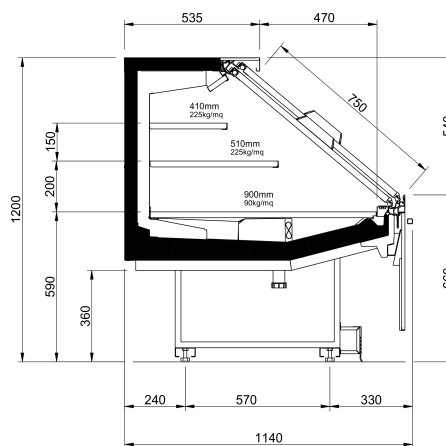

Kaleido Closed 12 M Design

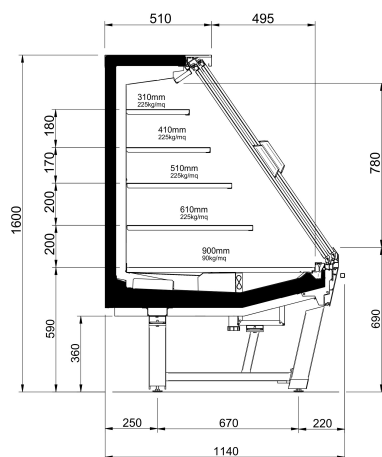

Kaleido Closed 16 M Style

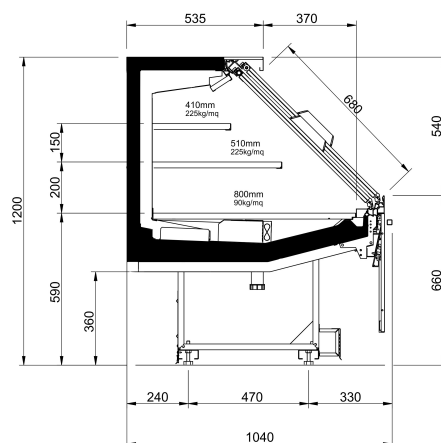

Kaleido Closed 12 E Design

KALEIDO CLOSED

Mozaik / Multideck

Serve-over

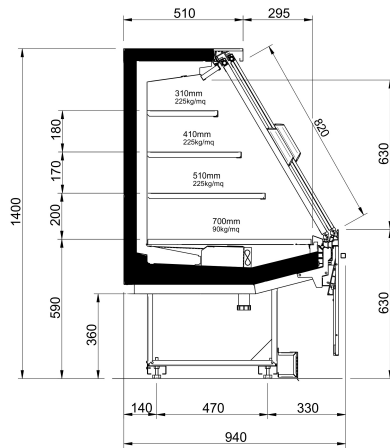

Kaleido Closed 14 S Design

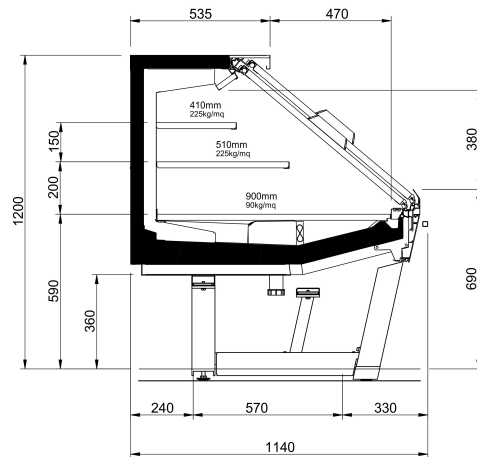

Kaleido Closed H12 M Style

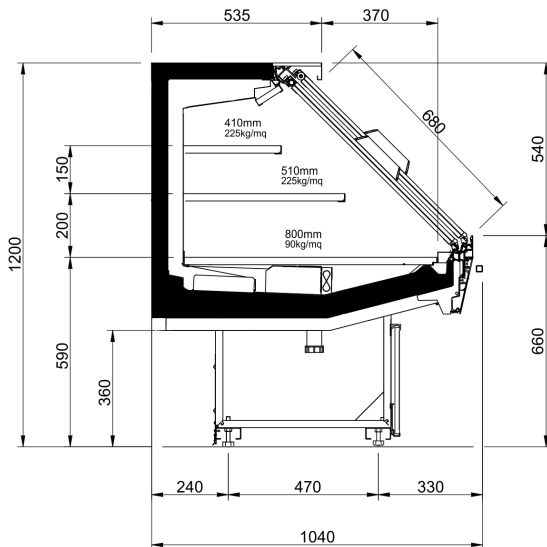

Kaleido Closed H12 E Studio

*The information on the energy class (according to EU regulations 2019/2018 and EU 2019/2024) reported here refers to standard models and precise product configurations and set-ups. The site is based on the information available at the time of publication. As the energy class depends on the specific product configuration, despite the efforts made to ensure the greatest possible accuracy, the real data can differ significantly from the data declared here. For further information, we invite you to consult the European Product Database for Energy Labelling (EPREL) or to contact our Sales Office.